

Panasonic®

Multimedia Projection Display Operating Instructions

Models No. **PT-43LC14/PT-50LC14/PT-60LC14**



MultiMediaCard™



(USA)

For assistance, please call :
1-888-VIEW PTV(843-9788)
or, contact us via the web at:
<http://www.panasonic.com/contactinfo>

(Puerto Rico)

For assistance, please call :
787-750-4300
or visit us at www.panasonicpr.com

Three Important Reasons to Register Your Product Immediately!

- 1 Protect Your New Investment...**
Register your new projection display for insurance purposes in case your new projection display is stolen.
- 2 Product safety notification...**
Registering your product can help us to contact you in the unlikely event a safety notification is required under the Consumer Product Safety Act.
- 3 Improved Product Development...**
Help us continue to design products that meet your needs.
Register online at www.panasonic.com/register



As an ENERGY STAR® Partner, Matsushita Electric Corporation of America has determined that this product or product model meets the ENERGY STAR® guidelines for energy efficiency.

This operating instruction book is designed for use with models PT-43LC14, PT-50LC14 and PT-60LC14. Illustrations in this manual show the PT-50LC14.

Before connecting, operating or adjusting this product, please read the instructions completely. Please keep this manual for future reference.

⚠ IMPORTANT SAFETY INSTRUCTIONS



This symbol warns the user that uninsulated voltage within the unit may have sufficient magnitude to cause electric shock. Therefore, it is dangerous to make any kind of contact with any inside part of this unit.



This symbol alerts the user that important literature concerning the operation and maintenance of this unit has been included. Therefore, it should be read carefully in order to avoid any problems.



The pictorial representation of a hot surface within a triangle is intended to tell the user that parts inside the product are a risk of burns to persons.

Note to CATV System Installer:

This reminder is provided to call the CATV system installer's attention to Article 820-40 of the NEC that provides guidelines for proper grounding and, in particular, specifies that the cable ground shall be connected to the grounding system of the building, as close to the point of cable entry as practical.

⚠ WARNING

- To reduce the risk of electric shock, fire, injury to persons or damage to this product:

- 1) **Read these instructions** before using, connecting or adjusting this product.
- 2) **Keep these instructions** for future reference.
- 3) **Heed all warnings** on the product and in this Operating Instructions manual.
- 4) **Follow all instructions** carefully.
- 5) **Do not use this product near water.** For example, near a bathtub, washbowl, kitchen sink, or laundry tub, in a wet basement or near a swimming pool, and the like. **Do not** place objects filled with water, such as a vase or the like, on top of this unit.
- 6) **Clean only with a dry cloth.** Do not use liquid cleaners or aerosol cleaners.
- 7) **Do not block any ventilation openings. Install in accordance with the manufacturer's instructions.** Openings in the cabinet are provided for ventilation to ensure reliable operation and to protect it from overheating. Never block openings by placing the product on a bed, sofa or similar surfaces.
- 8) **Do not install near any heat source such as radiators, heat registers, stoves, or other apparatus (including amplifiers) that produces heat. Do not** install in a built-in installation such as a bookcase or rack, unless proper ventilation is provided or the manufacturer's instructions have been adhered to.
- 9) **Do not defeat the safety purpose of the polarized or grounding-type plug. A polarized plug has two blades with one wider than the other. A grounding type plug has two blades and a third grounding prong. The wide blade or the third prong are provided for your safety. If the provided plug does not fit into your outlet, consult an electrician for replacement of the obsolete outlet.**
- 10) **Protect the power cord from being walked on or pinched particularly at plugs, convenience receptacles, and the point where they exit from the apparatus.**
- 11) **Use only attachments/accessories specified by the manufacturer.**
- 12) **Use only with the cart, stand, tripod, bracket, or table specified by the manufacturer, or sold with the apparatus. When a cart is used, use caution when moving the cart/apparatus combination to avoid injury from tip-over.**
- 13) **Unplug this apparatus during lightning storms or when unused for long periods of time.**
- 14) **Refer all servicing to qualified personnel. Servicing is required when the apparatus has been damaged in any way, such as power-supply cord or plug is damaged, liquid has been spilled or objects have fallen into the apparatus, the apparatus has been exposed to rain or moisture, does not operate normally, or has been dropped.**
- 15) Because the temperature of the lamp unit is elevated immediately after its use, a direct touch to it may cause burns. **Replace the lamp unit only after it has cooled.**



⚠ IMPORTANT SAFETY INSTRUCTIONS (CONTINUED)

⚠ WARNING

AS WITH ANY SMALL OBJECT, SD CARDS CAN BE SWALLOWED BY YOUNG CHILDREN. DO NOT ALLOW CHILDREN TO HANDLE THE SD CARD.

⚠ CAUTION

- (1) This projection display is intended to be used with the following TV stand: model TY-43LC14C for the PT-43LC14, TY-50LC14C for the PT-50LC14, and TY60LC14C for the PT-60LC14. Use with other stands may result in the projection display becoming unstable, possibly causing injury.
- (2) This projection display should not be exposed to direct sunlight, extreme temperatures or moisture, as this can result in serious irreparable damage.
- (3) This product has a High Intensity Discharge (HID) lamp that contains a small amount of mercury. It also contains lead in some components.
Disposal of these materials may be regulated in your community due to environmental considerations. For disposal or recycling information please contact your local authorities, or the Electronics Industries Alliance: <<http://www.eiae.org>>

The Lamp is a consumable item and has a life.
The lamp should be changed as soon as possible once the lamp warning message appears. (See page 73.)
If the lamp is damaged, please contact your nearest dealer.

Due to the characteristics and use conditions of individual lamps, the lamp may cease to light before the stated lamp life.
Influences of frequent lighting, continuous light use for over 24 hours, the number of times lit, the length of time between lightings, etc. may shorten lamp life.
(Because of this, we recommend having a replacement lamp on hand.)

Trademarks

- VGA and XGA are trademarks of International Business Machines Corporation.
- Macintosh is a registered trademark of Apple Computer, USA.
- VESA and SVGA are trademarks of the Video Electronics Standard Association.
Even if no special notation has been made of company or product trademarks, these trademarks have been fully respected.
- Equipped with **dbx**[®]-TV Noise Reduction for true MTS reproduction. **dbx**[®]-TV Noise Reduction is required for good stereo separation and audio fidelity. **dbx**[®] is a registered trademark, and is licensed by **dbx**[®] Technology Licensing.



SD Logo is a trademark.



Manufactured under license from BBE Sound, Inc.
Licensed by BBE Sound, Inc. under USP4638258, 4482866, 5510752 and 5736897. BBE and BBE symbol are registered trademarks of BBE Sound, Inc.



HDMI, the HDMI logo and High Definition Multimedia Interface are trademarks or registered trademarks of HDMI Licensing LLC.

Dear Panasonic Customer

Welcome to the Panasonic family of customers. We hope that you will have many years of enjoyment from your new projection display.

To obtain maximum benefit from your set, please read these Instructions before making any adjustments, and retain them for future reference.

Retain your purchase receipt also, and record the serial number of your set in the space provided on the rear cover of these instructions.

Visit our Panasonic Web Site for USA : www.panasonic.com

(USA)

For assistance, please call : 1-888-VIEW PTV(843-9788)
or, contact us via the web at: <http://www.panasonic.com/contactinfo>

(Puerto Rico)

For assistance, please call : 787-750-4300
or visit us at www.panasonicpr.com

FCC STATEMENT:

NOTE:

This equipment has been tested and found to comply with the limits for a Class B digital device, pursuant to Part 15 of the FCC Rules. These limits are designed to provide reasonable protection against harmful interference in a residential installation. This equipment generates, uses and can radiate radio frequency energy and, if not installed and used in accordance with the instructions, may cause harmful interference to radio communications. However, there is no guarantee that interference will not occur in a particular installation. If this equipment does cause harmful interference to radio or television reception, which can be determined by turning the equipment off and on, the user is encouraged to try to correct the interference by one or more of the following measures:

- Reorient or relocate the receiving antenna.
- Increase the separation between the equipment and receiver.
- Connect the equipment into an outlet on a circuit different from that to which the receiver is connected.
- Consult the dealer or an experienced radio / TV technician for help.

FCC CAUTION:

To assure continued compliance and prevent undesirable interference, use only the provided shielded RGB cable with 2 ferrite cores while connecting the projection display to a computer. Any changes or modifications not expressly approved by the party responsible for compliance could void the user's authority to operate this equipment.

Declaration of Conformity

Models Number: **PT-43LC14/PT-50LC14/PT-60LC14**
Trade Name: Panasonic
Responsible party: Matsushita Electric Corporation of America.
Address: One Panasonic Way Secaucus New Jersey 07094
Telephone number: 1-888-VIEW PTV(843-9788)

This device complies with Part 15 of the FCC Rules. Operation is subject to the following two conditions: (1) This device may not cause harmful interference, and (2) this device must accept any interference received, including interference that may cause undesired operation.

Table of Contents

To Start !	▲ IMPORTANT SAFETY INSTRUCTIONS 2	
	Dear Panasonic Customer..... 4	
	Before Using 6	
	Location of Controls 8	
	Installation..... 12	
<hr/>		
Use Now !	Power ON and OFF 22	Basic Operation
	Basic Menu Navigation 24	
	Tuning channels 26	
	Projection display operation 30	
	Searching for the desired channel (Channel search) 34	
	Playing peripheral equipment 35	
	Mute / Freeze / SAP 36	
Split screen 38		
<hr/>		
Enjoy More !	Adjusting screen position and size 40	Advanced Operation
	Audio Adjustments..... 42	
	Picture Adjustments..... 44	
	Lock Feature 46	
	Closed Captions 50	
	Input Label 52	
	Channel Caption Feature..... 53	
	Weak Signal Display Feature..... 54	
	Color Temp Feature..... 55	
	RGB Level Feature (RGB input only)..... 56	
	Video NR (Noise Reduction) Feature..... 57	
	Automatically changing screen size 58	
	Setting when 480p signals are input through COMPONENT VIDEO INPUT 59	
	RGB Input Feature..... 60	
	3D Y/C Feature 61	
	3D IP Feature..... 62	
	GAMMA Adjust Feature..... 63	
	Black Extension Feature..... 64	
	Color Correct Feature 65	
Sleep Timer Feature 66		
Switching languages for display..... 67		
Photo Viewer (SD Card/PC Card)..... 68		
<hr/>		
Other Information !	Replacing the lamp unit 73	Information
	Warning Indicators 74	
	Remote Control Quick Reference Guide (Operating peripheral equipment)..... 75	
	Troubleshooting 82	
	Specifications 83	
	Cleaning 84	
	Customer Services Directory 84	
	Limited Warranty 85	
Index 87		

Getting Started

Basic Operation

Advanced Operation

Information

Before Using

Receiver Location

This projection display is intended to be used with an optional stand or entertainment center. Consult your dealer for available options.

Locate for comfortable viewing. Avoid placing where sunlight or other bright light (including reflections) will fall on the screen.

Use of some types of fluorescent lighting can reduce remote control transmitter range.

Adequate ventilation is essential to prevent internal component failure. Keep away from areas of excessive heat or moisture.

Optional External Equipment

The Video / Audio connection between components can be made with shielded video and audio cables. For best performance, video cables should utilize 75 Ω coaxial shielded cables. Cables are available from your dealer or electronic supply house.

Before you purchase any cables, be sure you know what type of output and input connectors your various components require. Also determine the length of cable you'll need.

Safety Precaution

Please take safety precautions to prevent the unit from falling over.

⚠ WARNING

The unit may tip or fall if not situated on a stable surface, if pushed or during an earthquake. Use a strong rope or chain (not included) to fasten the projection display firmly to a strong wall support.

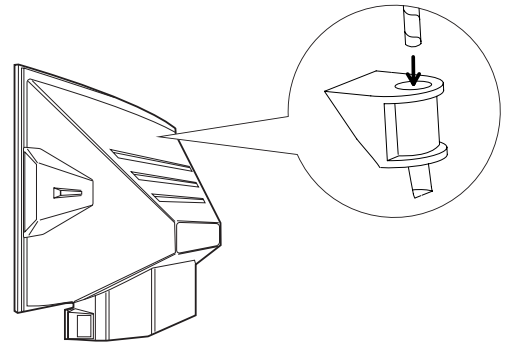

Viewing position

To optimize your viewing comfort, please follow the viewing guidelines shown in the diagrams below.

If viewing for an extended period of time, sit as far back from the screen as possible.

<Top view>

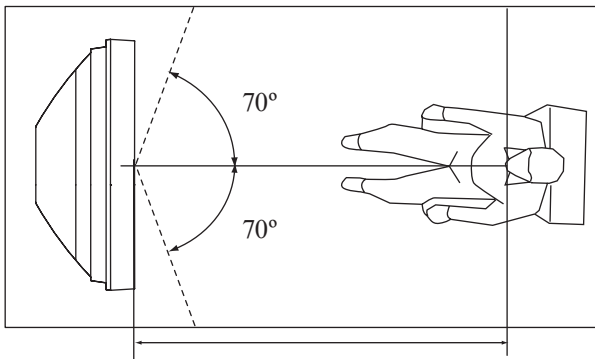

At least 1.6 m (PT-43LC14) / 1.8 m (PT-50LC14) / 2.2 m (PT-60LC14).

<Side view>

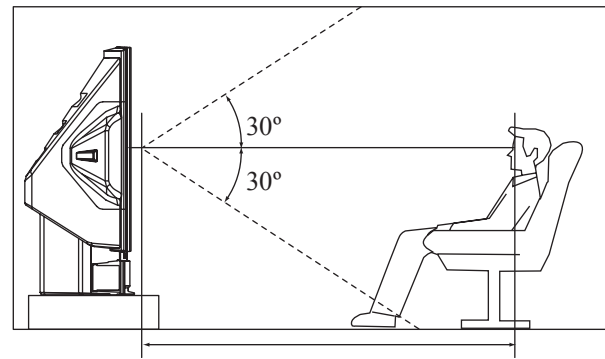

At least 1.6 m (PT-43LC14) / 1.8 m (PT-50LC14) / 2.2 m (PT-60LC14).

Accessories

1. Remote Control (EUR7627Z20)
2. Batteries 2 "AA"
3. RGB Cable (2 m) (LSJA0239-1 or LSJA0443)

Remote Control Battery Installation

Requires two AA batteries (supplied).

1. While pressing in on the catch, open cover in direction of arrow.
2. Install the batteries as shown in the battery compartment. (Polarity + or - must match the markings in the compartment).
3. Press cover in direction of arrow until it snaps shut.

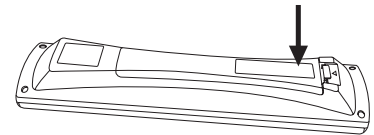
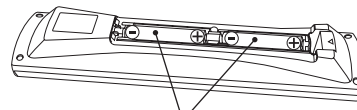
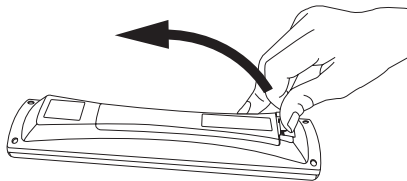

CAUTION

Incorrect battery installation can cause the batteries to leak, leading to personal injury and/or damage to the remote control.

Observe the following precautions:

1. Batteries should always be replaced as a pair. Always use new batteries when replacing the old set.
2. Do not mix battery types (example: "Zinc Carbon" with "Alkaline").
3. Do not attempt to charge, short-circuit, disassemble, heat or burn used batteries.
4. Battery replacement is necessary when the remote control acts sporadically or stops operating the projection display set.

Helpful Hints:

- (1) For frequent remote control users, replace old batteries with Alkaline batteries for longer battery life.
- (2) Whenever you remove the batteries, **you may need to reset the remote control infrared codes**. We recommend that you record the code on page 76, prior to setting up the remote.

Location of Controls

Illuminated Remote Control

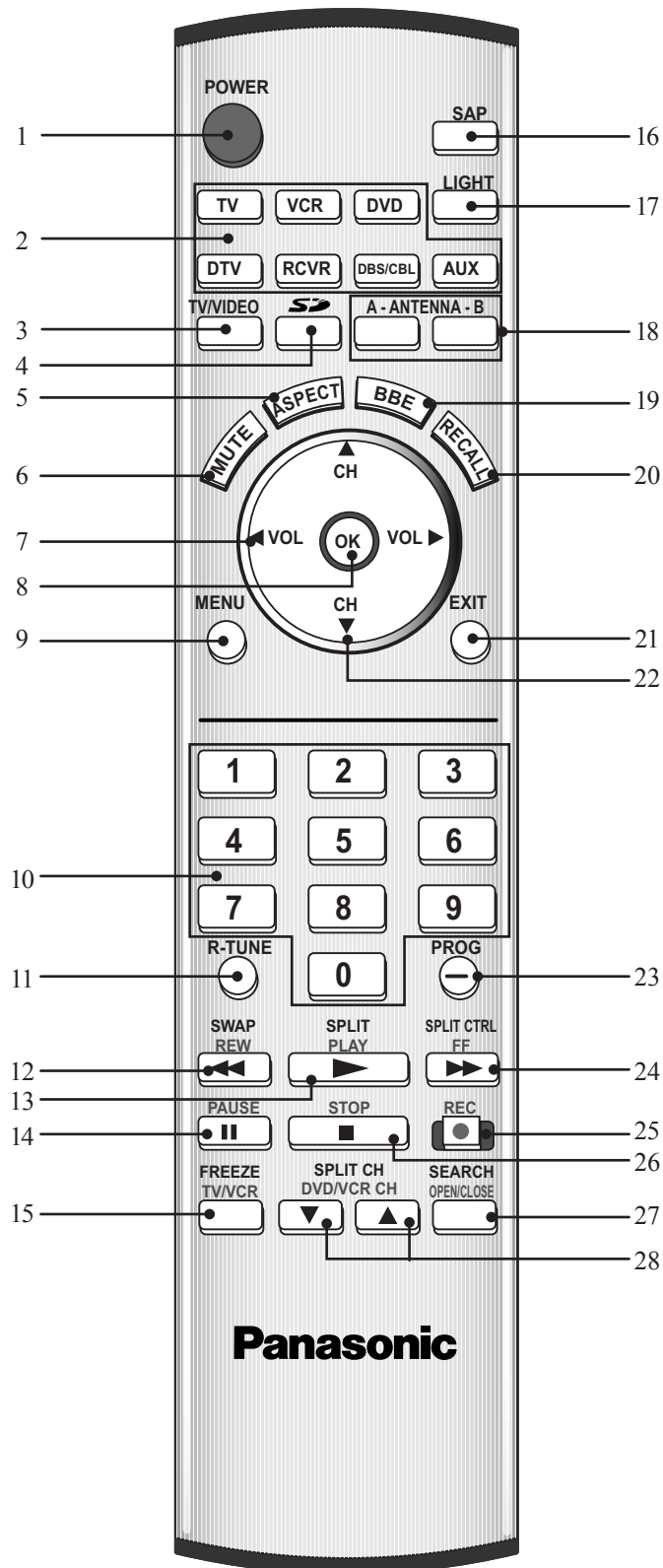

Note:

• This section describes TV mode only. For other modes, see pages 75-81.

Location of Controls

	Remote Keys	DESCRIPTION
1	POWER	Press to turn ON and OFF.
2	TV	Sets the remote to communicate with television.
	VCR, DVD, DTV, RCVR, DBS/CBL, AUX	Sets the remote to communicate with other devices.
3	TV/VIDEO	Changes Input source.
4	SD	Accesses the Photo Viewer feature (SD Card or PC Card).
5	ASPECT	Changes display aspect ratio.
6	MUTE	Press to mute sound.
7	VOL ◀▶	Press to adjust TV sound and navigate in menus.
8	OK	Press to choose menu and sub-menu entry.
9	MENU	Press to display Main Menu or return one step backward in menus.
10	Number	Press numeric keypad to select any channel or press to enter alphanumeric input in menus.
11	R-TUNE	Press to switch to previously viewed channel, Photo Viewer or input modes.
12	SWAP	Press to swap Main screen with Split screen.
	REW	While remote is in VCR or DVD mode, press to rewind.
13	SPLIT	Press to display or delete Split screen.
	PLAY	While remote is in VCR or DVD mode, press to play.
14	PAUSE	While remote is in VCR or DVD mode, press to pause.
15	FREEZE	Still full video window.
	TV/VCR	Press to switch to TV or VCR.
16	SAP	Changes the audio mode.
17	LIGHT	Lights all buttons. The selected mode button (TV, VCR, etc.) flashes.
18	ANTENNA A/B	Changes the antenna input of an external device.
19	BBE	Toggles between BBE, BBE VIVA, and OFF.
20	RECALL	Press to display or delete current TV status information.
21	EXIT	Press to exit menus.
22	CH ▲▼	Press to change channels and navigate in menus.
23	PROG	Press when entering channels of an external device.
24	SPLIT CTRL	Press when operating an external device.
	FF	While remote is in VCR or DVD mode, press to fast forward.
25	REC	While remote is in VCR mode, press to record.
26	STOP	While remote is in VCR or DVD mode, press to stop.
27	SEARCH	While remote is in TV mode, press to scan available channels in search screens. Press again to delete search screens.
	OPEN/CLOSE	While remote is in DVD mode, press to open or close DVD tray.
28	SPLIT CH ▲▼	While remote is in TV mode, press to change channels for SPLIT.
	DVD/VCR CH	While remote is in VCR or DVD mode, press to change channels for DVD or VCR.

Location of Controls

Controls and Terminals on the projection display

Model PT-50LC14 unit shown

< FRONT >

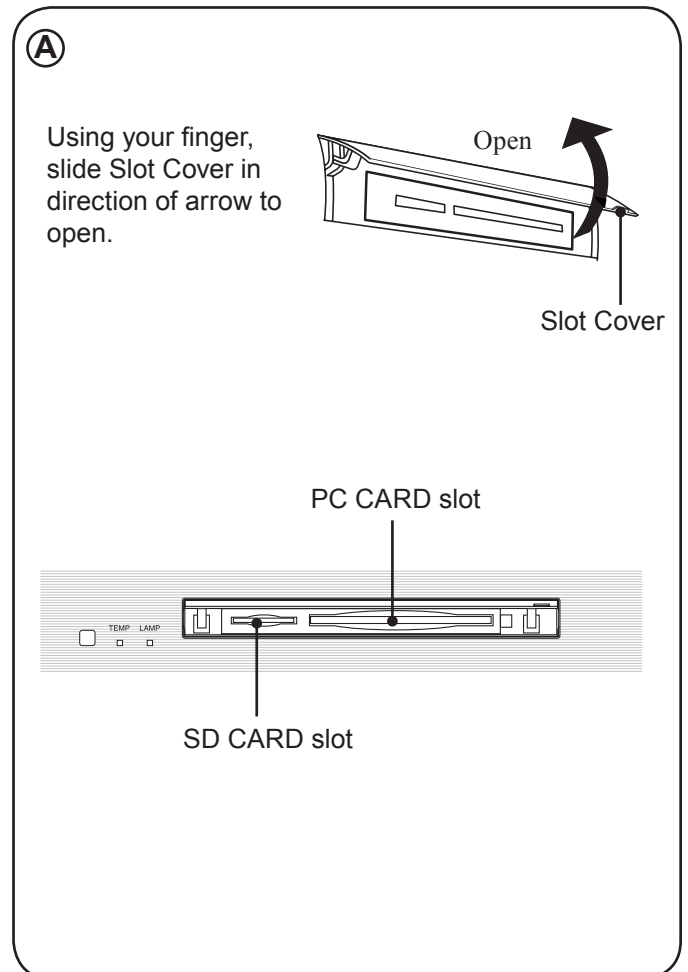
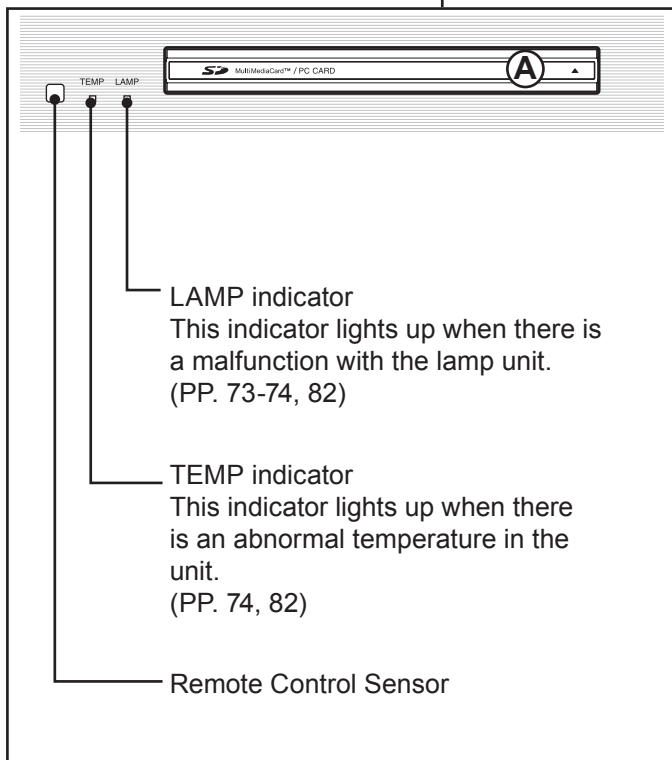
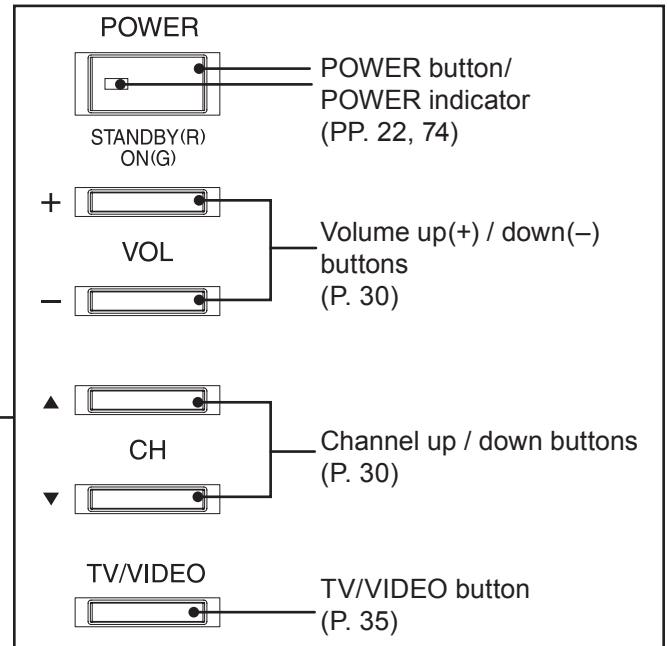
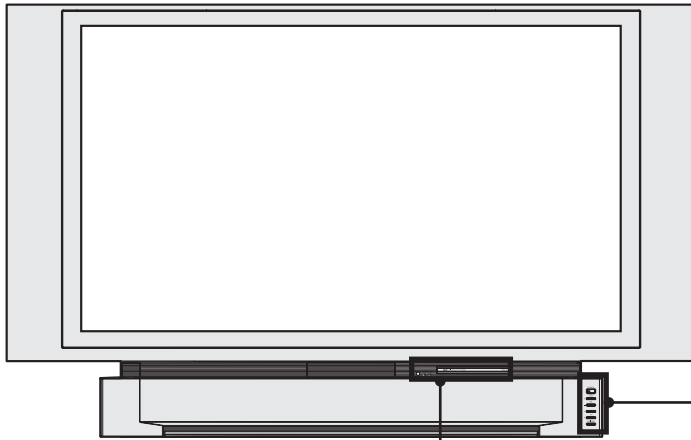

Location of Controls

Model PT-50LC14 unit shown

< REAR >

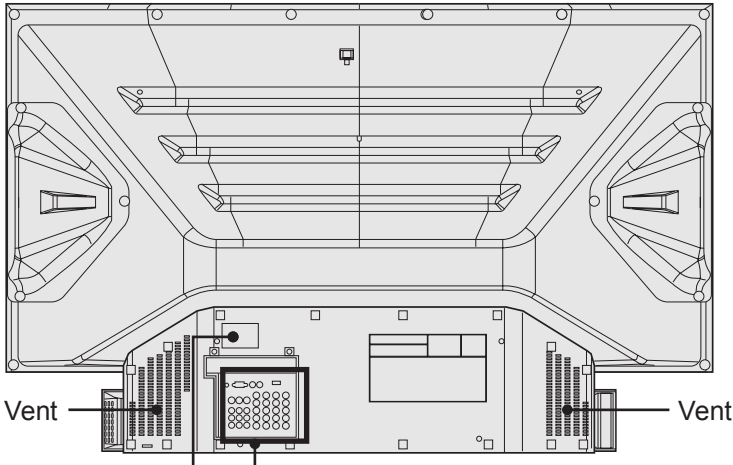

< SIDE >

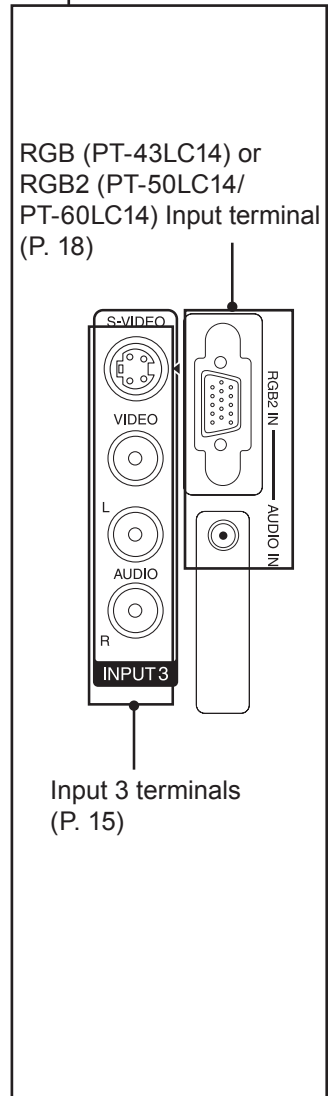
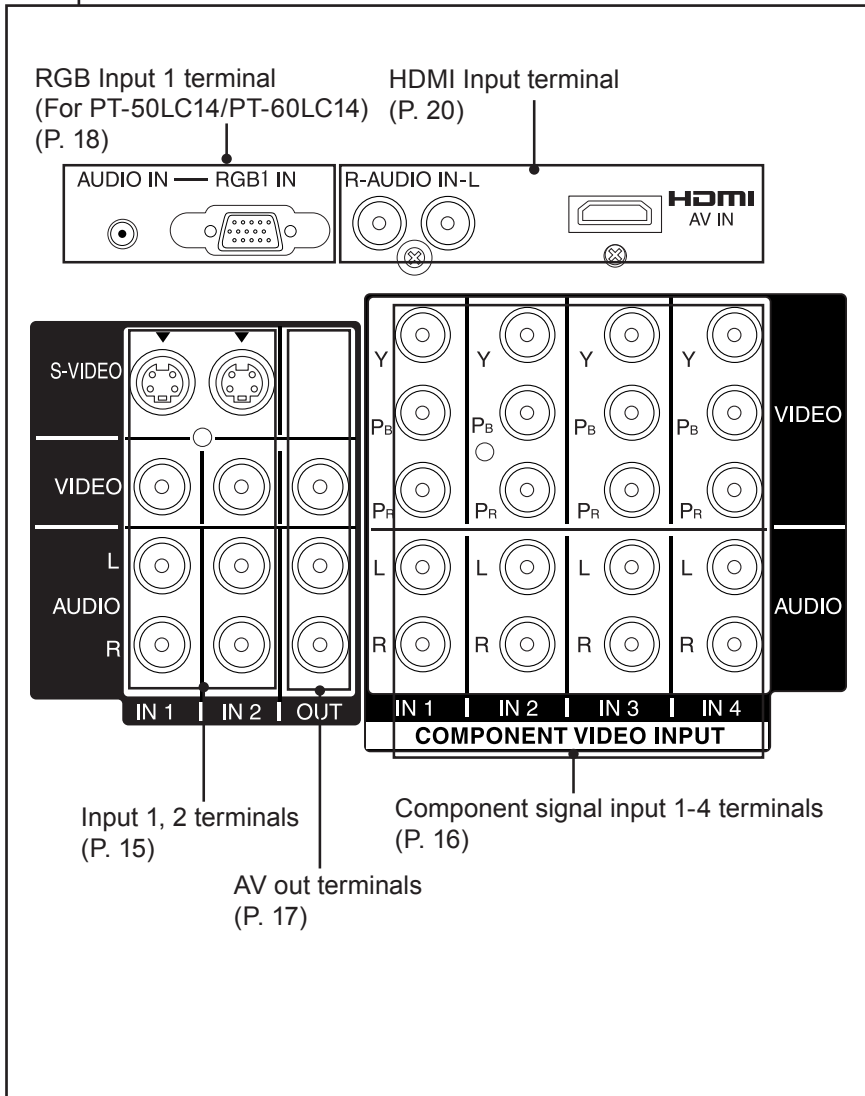
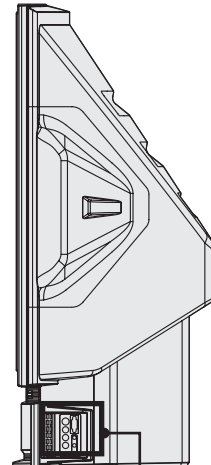

Note:

- Make sure the vents are not blocked. (This could cause damage.)

Installation

Notes on connections

- Turn off the power supply for all components before making any connections.
- If the cables necessary for connecting a component to the system are not included with the component or available as an option, you may need to fashion a cable to suit the component concerned.
- Read the instruction manual for each system component carefully before connecting it.
- If there is a lot of jitter in the video signal input from the video source, the picture on the screen may flicker. In this case, it will be necessary to connect a TBC (time base corrector).

Connecting the Antenna / Cable to the RF IN Terminal (No VCR)

Antenna Connection

For proper reception of VHF/UHF channels, an external antenna is required. For best reception an outdoor antenna is recommended.

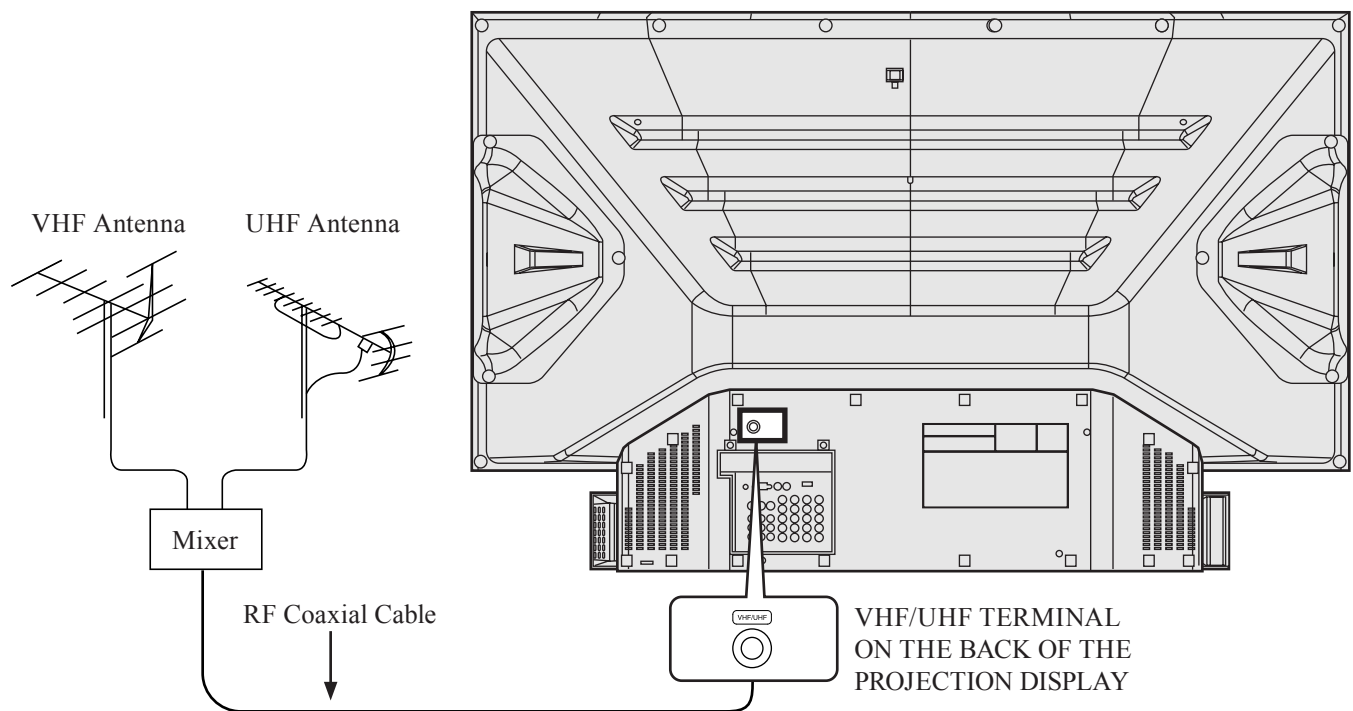

CAUTION

When using “Nut type” RF coaxial cables, tighten with fingers only. Overtightening may damage terminals.

Cable Connection

Use this configuration when connecting the projection display to a cable TV system.

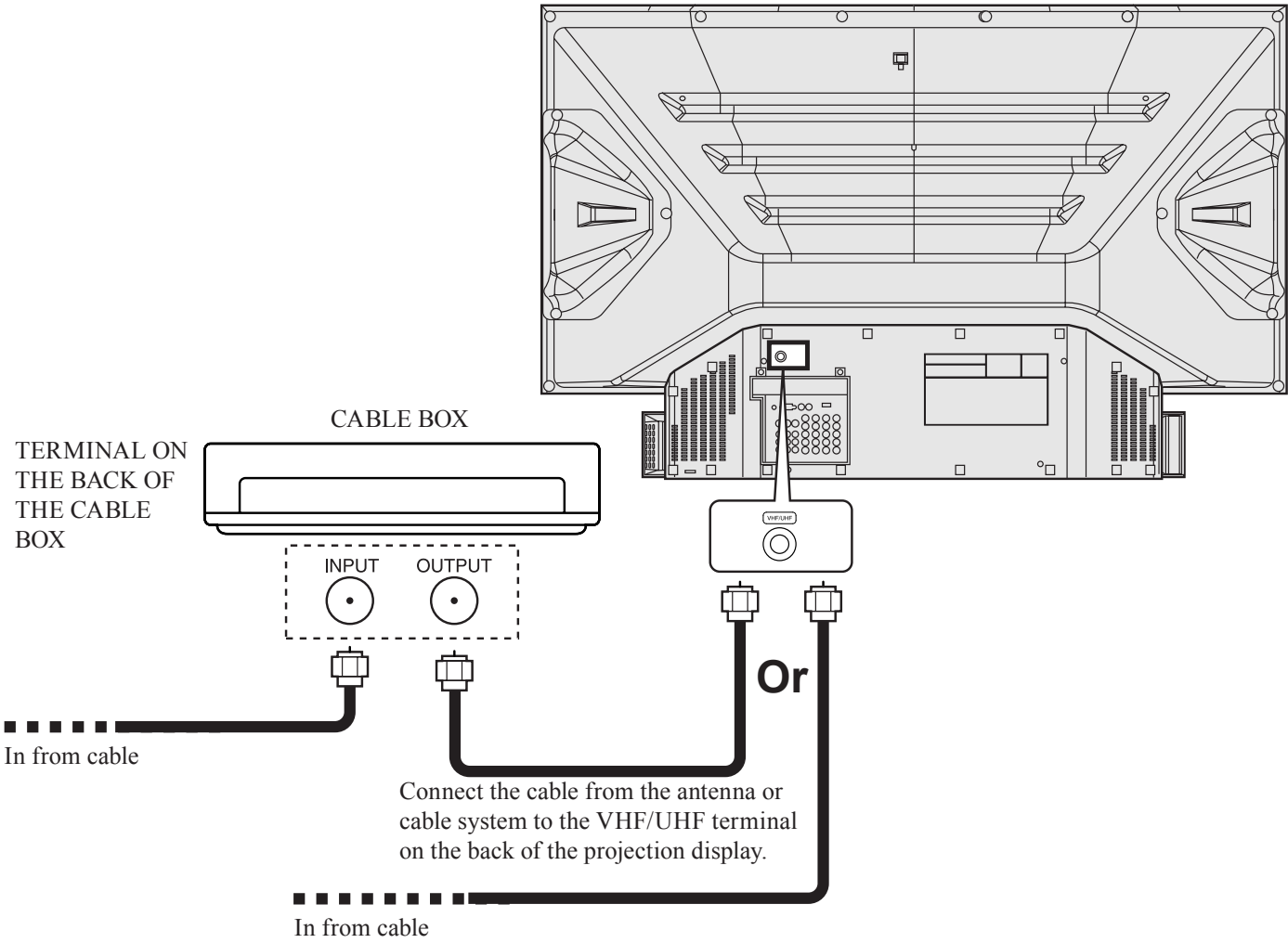

Notes:

- Certain cable systems offset some channels to reduce interference or have Premium (scrambled) channels. A cable converter box is required for proper reception. Check with your local Cable company for its compatibility requirements.
- For reception of cable channels (01 - 125) connect the cable supplied by your local cable company. Antenna Mode must be set to CABLE. (P. 26)

Installation

Connecting the Antenna / Cable to the RF IN Terminal (VCR)

Use this configuration when connecting the projection display to a cable TV system using VCR.

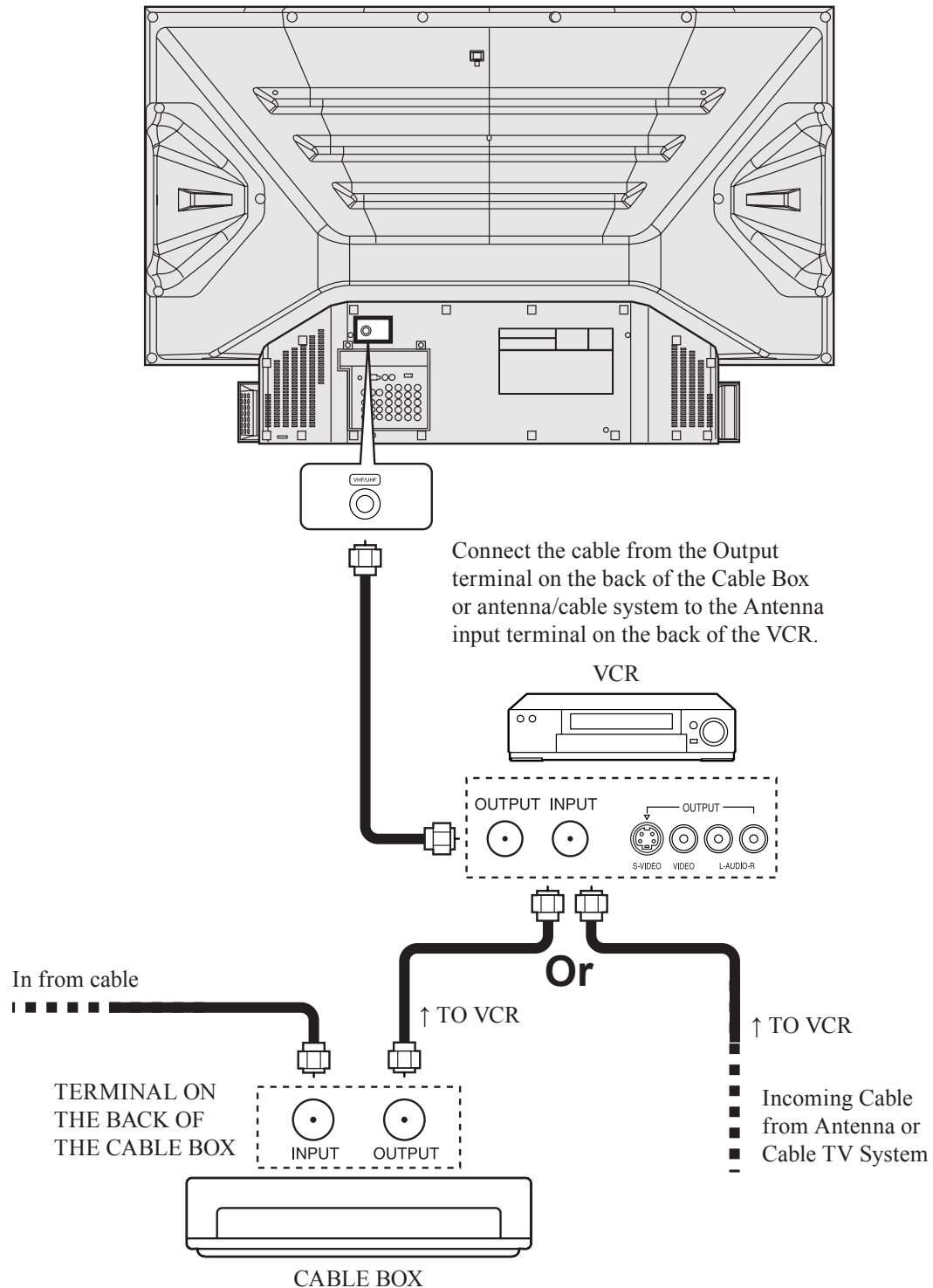

Note:

- When the RF coaxial cable is connected to the projection display VHF/UHF terminal via a cable box or VCR, set the TV channel to CH3 or CH4. This does not apply when signal is input from VIDEO INPUT.

How to connect the “1, 2, 3” Input Terminals

Connects VCRs and other peripheral equipment

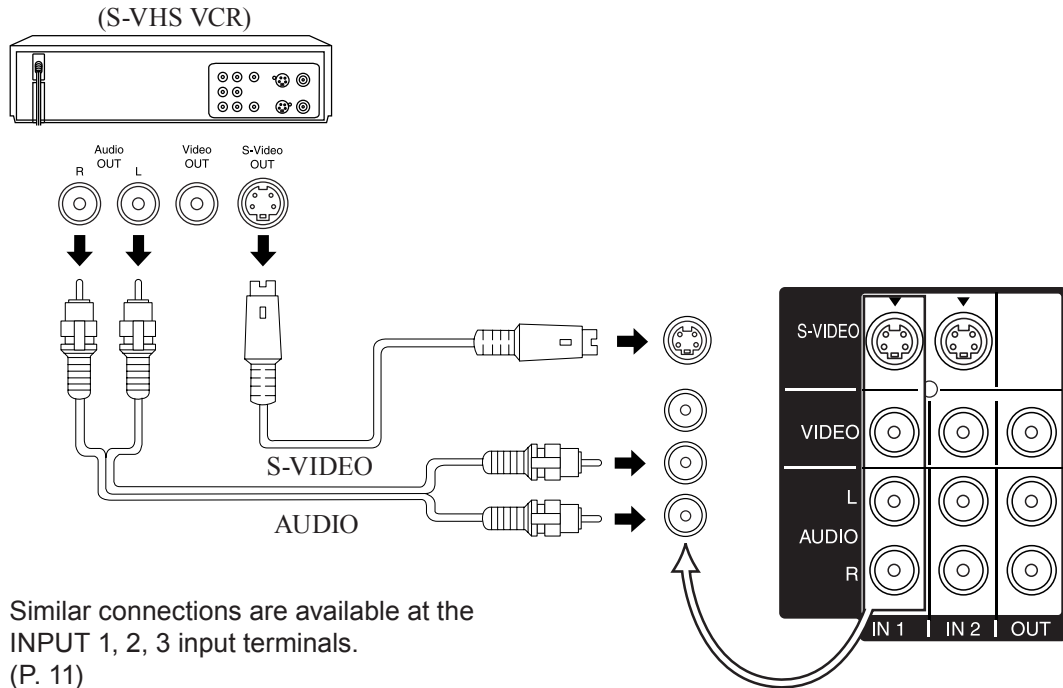

Similar connections are available at the INPUT 1, 2, 3 input terminals. (P. 11)

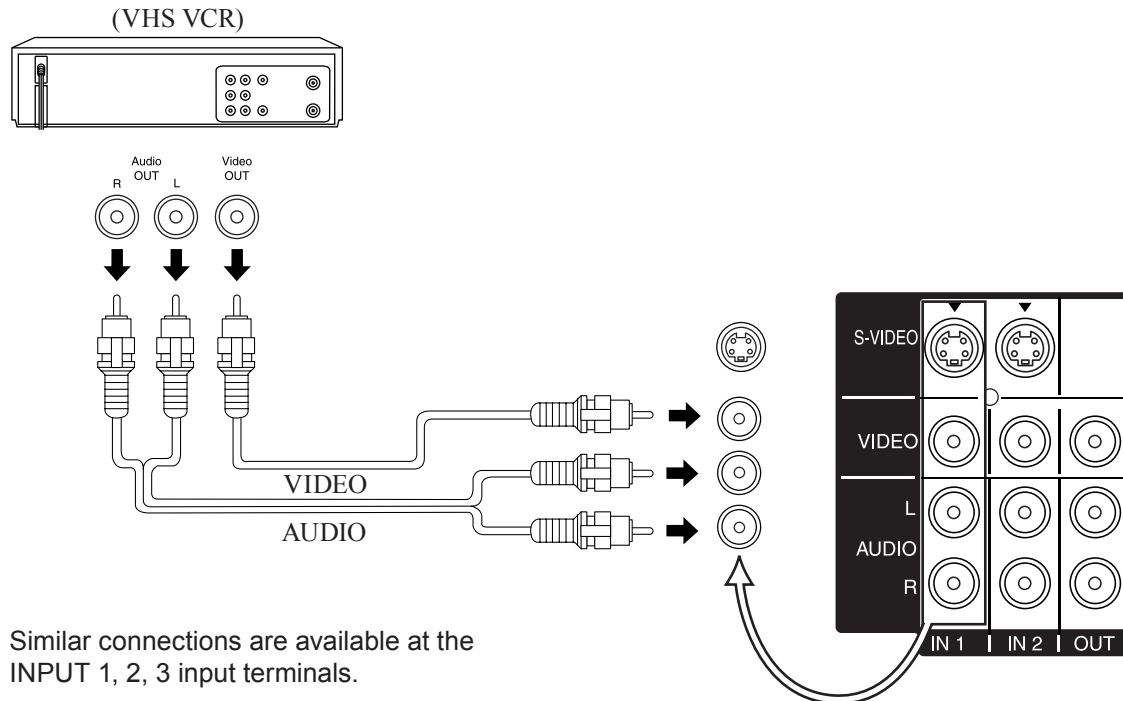

Similar connections are available at the INPUT 1, 2, 3 input terminals.

Notes:

- Similar connections are available at the INPUT 1, 2, 3 input terminals.
- Input 3 is located on the side of the unit.
- Select the desired VIDEO input position by pressing the TV/VIDEO button. (P. 35)
- When connecting video cables, priority is given to the S-Video cable when the S-Video input terminal and the video input terminal are connected at the same time.

Installation

How to connect the COMPONENT VIDEO Input Terminals

Because each Y, PB, and PR signal is input independently, the Component signal allows for more accurate color reproduction.

The Component signal output terminal indication will differ according to the output device (Y, PB, PR). Please read the operating instructions included with the output device.

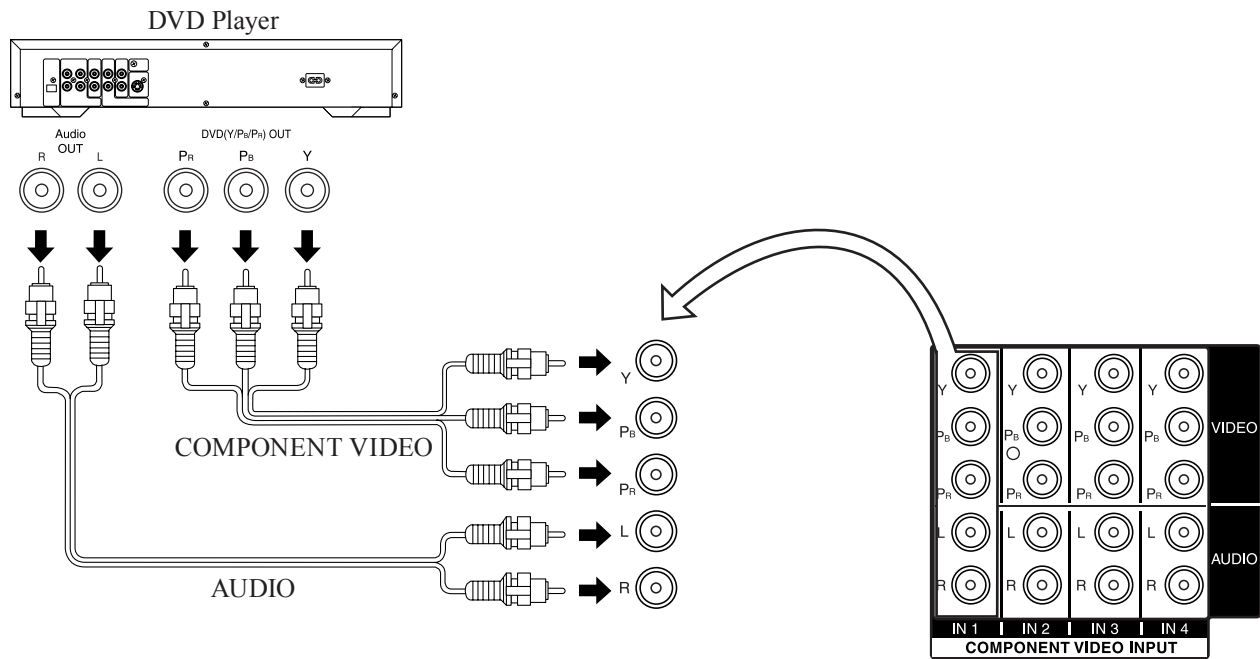

Notes:

- Similar connections are available at the COMPONENT VIDEO INPUT 1-4 Terminals.
- Select the desired COMPONENT VIDEO INPUT position by pressing the TV/VIDEO button. (P. 35)
- Component video signals that can be input are 480i, 480p, 720p, and 1080i.

Component Signals (Y, PB, PR) that can be Input

Mode type	Signal data			Information menu display
	No. of dots (H X V)	Horizontal frequency (kHz)	Vertical frequency (Hz)	
DTV Format Signals	480i	664 X 485	15.73	480 i
	480p	720 X 483	31.47	480 p
	720p	1 280 X 720	45.00	720 p
	*1080i	1 920 X 1 080	33.75	1080 i

Note:

- Input signals, other than those listed with a * mark, will give you a beautiful, stable picture.

How to connect the AV OUT Terminals

The "AV Out" Terminals output the same signals as the main picture on the projection display screen and sound from the speaker at that time, e.g. TV programs or signals from INPUT 1, 2, 3 terminals.

Recording Equipment
(VHS VCR)

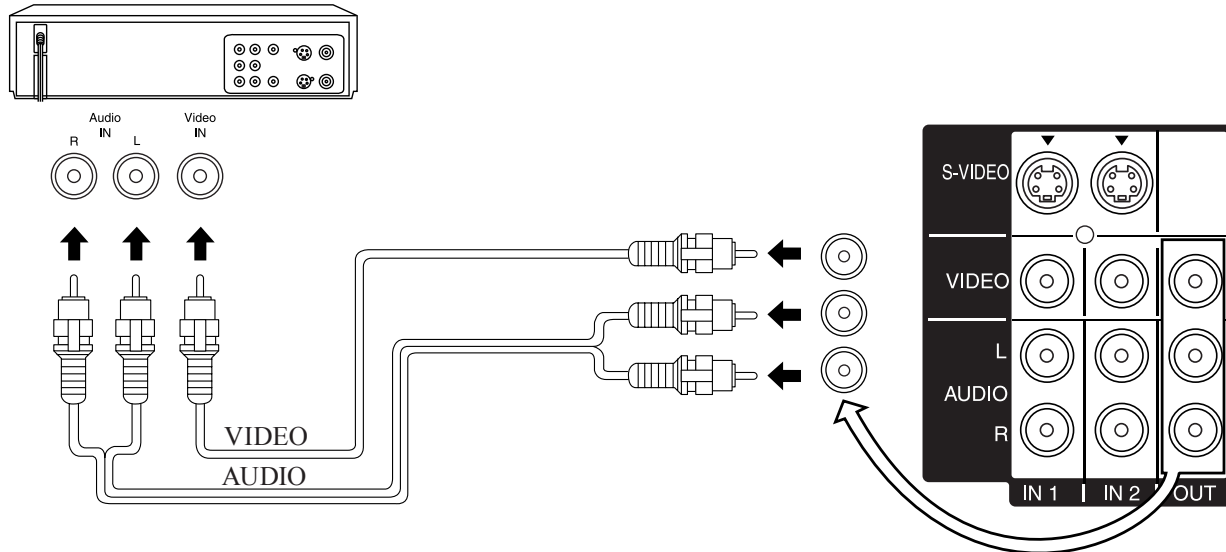

Stereo System
(A Stereo Amplifier and Speakers)

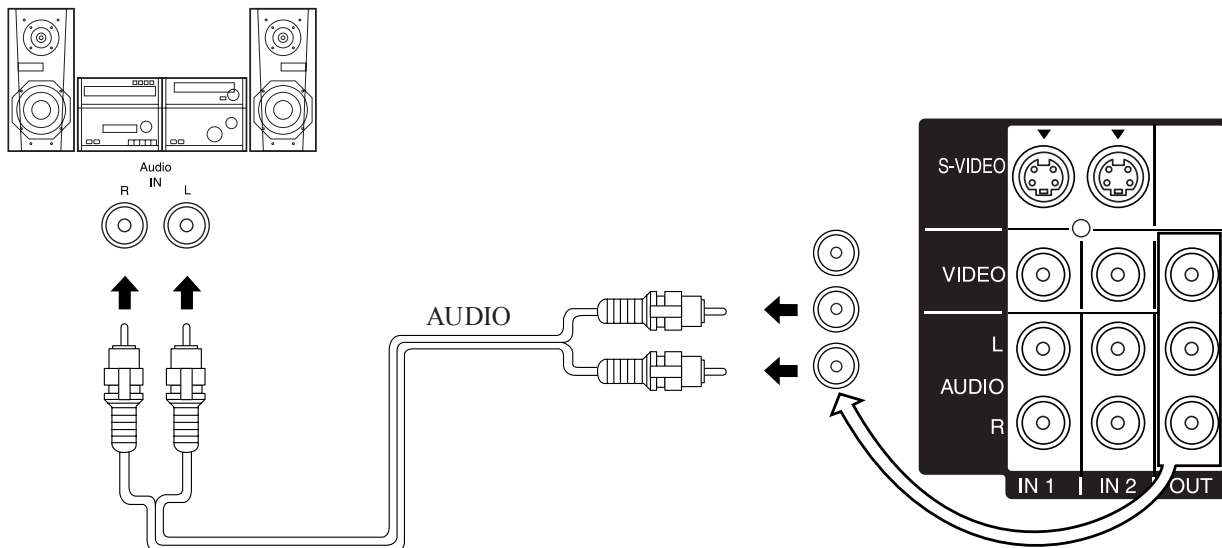

Notes:

- This unit contains Video and Audio Outputs for the purpose of recording television programming to VCR. Due to license restrictions, if a device (STB, DVD, etc.) is connected to the HDMI input of the unit, no video or audio output is allowed.
- Never connect the VIDEO IN and OUT terminals to the same video recorder, as this could cause incorrect operation.
- Even if TV is in Split mode, OUT terminals only output the main picture and sound signals. A sub-picture, including channel search, etc., will not be output.
- VIDEO OUT terminals will not output Y, Pb, Pr, RGB/HDMI IN or SD/PC card signals.

Installation

How to connect the RGB IN Terminals

Connecting a PC to RGB IN

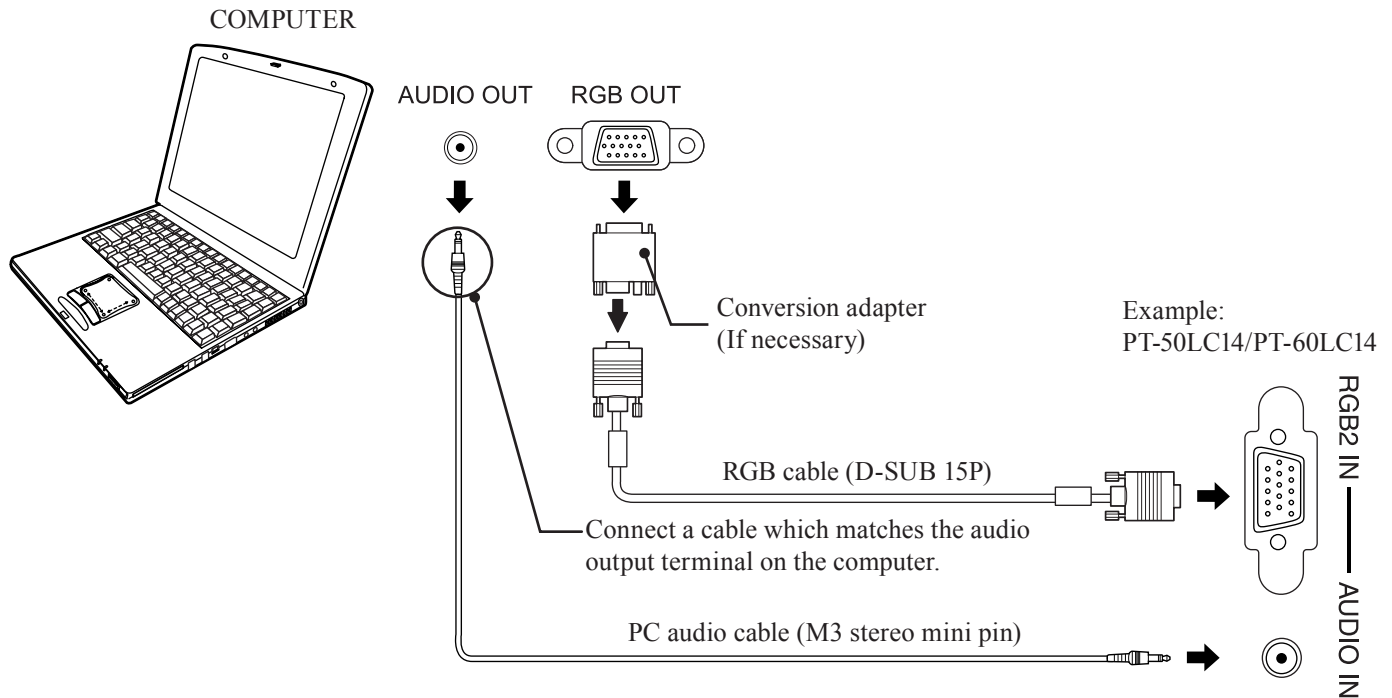

RGB IN Terminal (D-SUB 15P) Pin Layouts

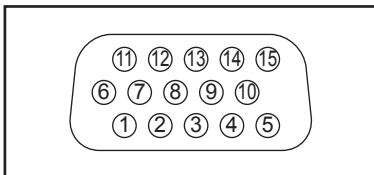

Connection port view

Pin No.	Signal name	Pin No.	Signal name
1	R	9	NC
2	G	10	Ground
3	B	11	NC
4	NC	12	NC
5	NC	13	HD/CSYNC
6	Ground for R	14	VD
7	Ground for G	15	NC
8	Ground for B		

NC: Not connected

Notes:

- Some PC models cannot be connected to the set. A conversion adapter is required to use the RGB cable (D-SUB 15P) to connect a Macintosh computer to the set. There is no need to use an adapter for computers with PC / AT compatible D-SUB 15P terminal.
- The computer shown in the illustration is for example purposes only. Additional equipment and cables shown are not supplied with this set.
- Do not set the horizontal and vertical scanning frequencies for PC signals which are above or below the specified frequency range.
- Select the desired RGB input position by pressing the TV/VIDEO button. (P. 35)
- Similar connections are available at the RGB IN 1, 2 Terminals (For PT-50LC14/PT-60LC14).

RGB signals that can be input

The table below lists the different types of RGB signals that can be input.

If a signal which differs greatly from any of the types listed below is input, the picture image may not be displayed correctly, or a black background may be displayed. At this time, "signal" will flash in the on-screen display for about 5 seconds.

Mode type		Signal data			display
		No. of dots (H X V)	Horizontal frequency (kHz)	Vertical frequency (Hz)	
Personal Computer Signals	VGA400 (70 Hz)	640 X 400	31.47	70.08	VGA400 70
	VGA480 (60 Hz)	640 X 480	31.47	59.94	VGA 60
	SVGA (60 Hz)	800 X 600	37.88	60.32	SVGA 60
	XGA (60 Hz)	1 024 X 768	48.36	60.00	XGA 60
DTV Format Signals	480i	664 X 485	15.73	29.97	480 i
	480p	720 X 483	31.47	59.94	480 p
	720p	1 280 X 720	45.00	60.00	720 p
	1080i	1 920 X 1 080	33.75	30.00	1080 i

Notes:

- The D-SUB15P connector can accept RGB (H-V sync separate).
- When used with an external video processor/scaler, it must have RGB (H-V sync separate) output.

Installation

How to connect the HDMI Input Terminal

About HDMI

HDMI is the first all digital consumer electronics A/V interface that supports several uncompressed standard, enhanced and high definition video format as well as all existing multi-channel audio formats. One jack supports both video and audio information. The HDMI/HDCP^{*1} input can be connected to an EIA/CEA 861/861B^{*2} compliant consumer electronic device, such as a set top box or DVD player equipped with a HDMI output connection. By inputting a High-bandwidth Digital Content Protection (HDCP) high definition picture source to the HDMI terminal of this unit, high definition pictures can be displayed on the screen in their digital form. The HDMI input terminal is not intended to be used with personal computers. This unit is compatible with 1080i, 720p and 480p formats. Select the output of the connected device to match that of the unit.

Connection diagram

Follow the diagram below to connect the unit to a set top box or a DVD player.

When audio signal input is digital.

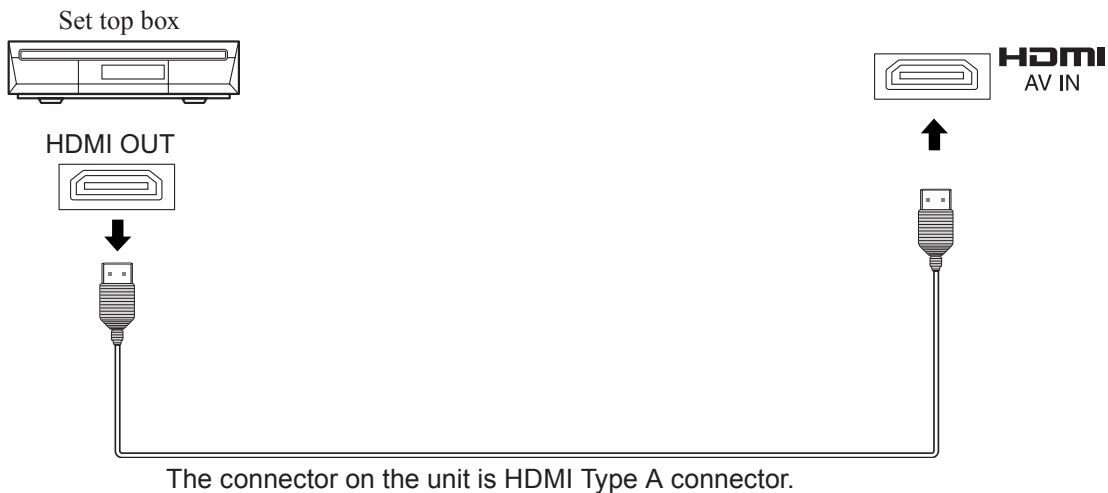

When audio signal input is analog.

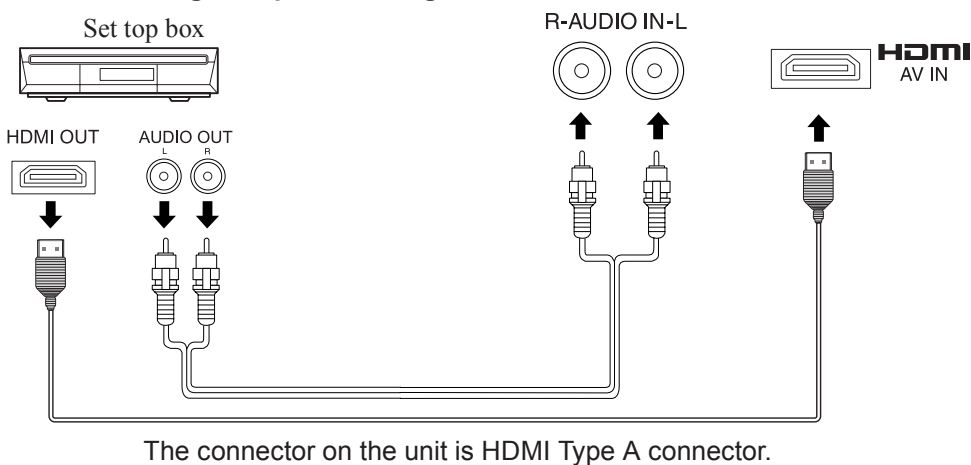

Notes:

^{*1} HDMI/HDCP = High Definition Multimedia Interface / High-Bandwidth Digital Copy Protection.

^{*2} EIA/CEA-861/861B Profiles compliance covers profiles for transmission of uncompressed digital video including high bandwidth digital content protection.

Procedure

- 1** Connect the HDMI output from the set top box or a DVD player to the HDMI input on the back of the unit.
 - If you cannot display the picture because your Digital Set Top Box does not have a Digital Out terminal setting, use the Component Video Input (or the S-Video Input or Video Input). In this case, the picture will be displayed as an analog signal.

- 2** Press TV/VIDEO on the Remote Control to select HDMI input.

By inputting a High-bandwidth Digital Content Protection high-definition picture source to the HDMI IN terminal of this Device Display, high-definition pictures can be displayed on the screen in their digital form. (This terminal is for use in the future when High-bandwidth Digital Content Protection DVD players and D-VHS are put on the market.)

Notes:

- Select the HDMI input position by pressing the TV/VIDEO button. (P. 35)
- The HDMI IN terminal can only be used with 1080i, 720p and 480p picture signals.
- If there is no audio, check if the source equipment has PCM output. If not, please use analog connections.
- Be sure HDMI is securely connected. If not, picture noise and/or incorrect picture display may result.

Compatible formats

Video Signal:

The Device display is compatible with following formats. Please set the connecting device to following format.

Display mode	No. of dots	Vertical scanning frequency (Hz)
1080i	1920 x 1080i	59.94 / 60
720p	1280 x 720p	59.94 / 60
480p	720 x 480p	59.94 / 60
	640 x 480p	59.94 / 60

Audio signal (PCM)

Please see "AUDIO SELECT" on page 43.

Power ON and OFF

Turning the Power ON and OFF

Always be sure to follow the procedure given below to turn the projection display power ON and OFF.

- The lamp cooling fan will continue to operate for approximately 1 minute after the power is turned off. At the same time, the POWER indicator will blink Red.

Do not disconnect the power cord from the outlet and do not open the circuit breaker (unless necessary) while the cooling fan is still operating. Do not disconnect the power cord from the power outlet while the power indicator blinks Red.

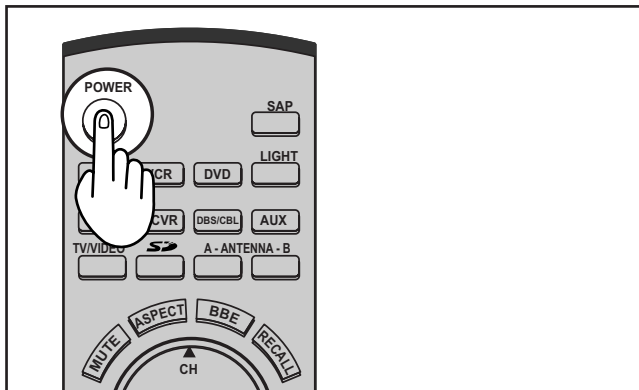
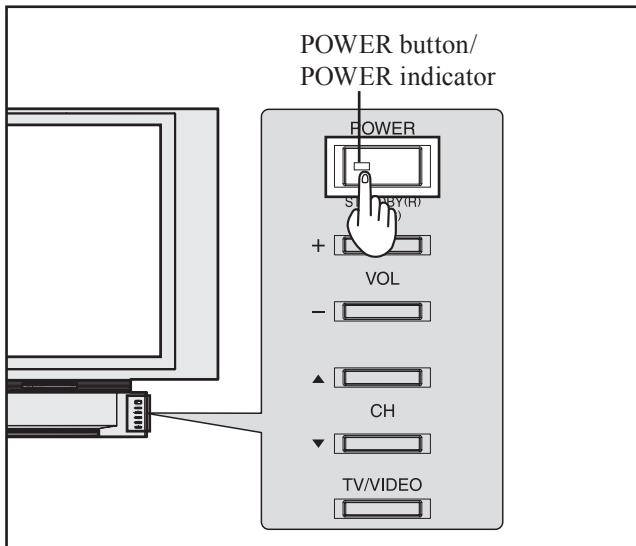

Note:

- When the AC Cord is unplugged, the internal cooling fan stops operating. In this case, the lamp will be insufficiently cooled and will take a while to turn ON again.

Power ON

Press POWER on projection display or Remote Control to turn power on.

The Power Indicator blinks Green for about 10 seconds and then turns solid Green.

Power OFF

Press POWER on projection display or Remote Control to turn power off.

Power shuts off after a Black Screen is displayed for a few seconds.

Note:

- If POWER is pressed during the Black Screen display, Power is turned back on.

The Power Indicator blinks Red for about 1 minute and then turns solid Red.

The Power Indicator

LED	ACTION
Red	Power – OFF (Standby mode)
Red blink	Power – OFF (Now cooling)
Green	Power – ON
Green blink	Power – ON (Preparing to light lamp)

Notes:

- If the POWER button is accidentally turned off during use, after power is turned back on, it may take a short period before the lamp automatically comes on.
- After the unit is turned on, maximum picture brightness will be achieved in 5-10 minutes. This is normal.

First Time Setup

In order to view TV or Cable programs, it is necessary to perform channel setting.
If needed, follow the menus and procedures displayed on-screen for setting up the features.



Input Setup

To select the configuration of RF input depending on the signal source.

Procedure

1 Press 1, 2 or 3 to select language.

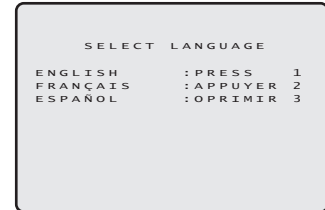

2 Press OK to select Cable or TV.
Press ► to next.

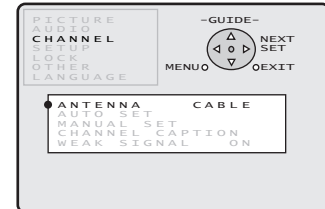

3 Press OK to start the Auto Scan.
After Auto Scan is completed the unit tunes to the first channel found during auto scan.

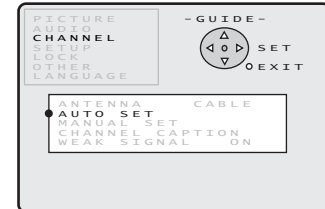

Notes:

- To cancel AUTO SET in progress, press the EXIT button.
- If setup is incomplete, check connection of Antenna/Cable to the RF IN Terminal, then try Auto Scan again. (PP. 26-27)

Case 1

When setup is complete, the lowest channel picture appears.

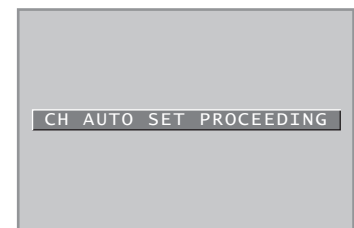

Case 2

If setup is incomplete, the following screen appears. Check connection of Antenna/Cable to the RF in Terminal, then try Automatic Channel Setting again. (PP. 26-27)

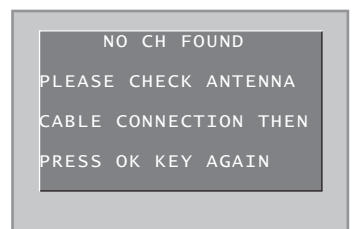

Basic Menu Navigation



1 Pressing the MENU button displays the MENU screen.

MENU



Note:

- Depending on the signal being input, some items may or may not be adjustable and some functions may or may not be available.

2

Press

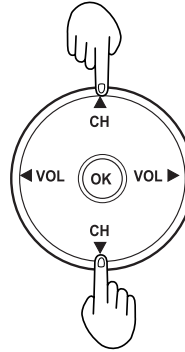

to select the desired menu.

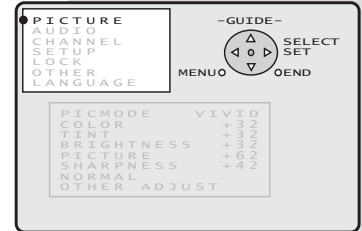

Press

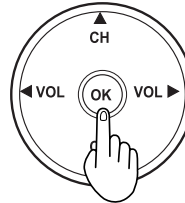

to enter the menu.

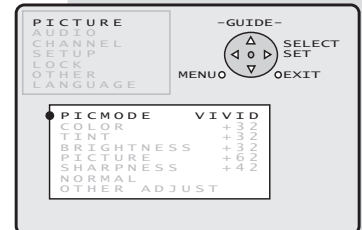

Press

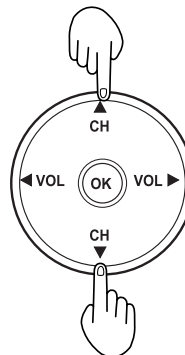

to select desired menu item.

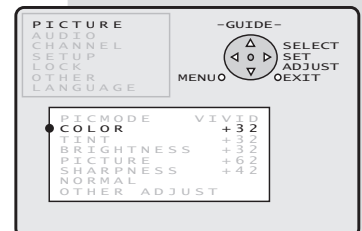

Continued in left column of next page.

Basic Menu Navigation

Continued from page 24.

Press  to adjust or set desired menu item.



Note: For OTHER ADJUST sub-menu

Press  to select OTHER ADJUST.

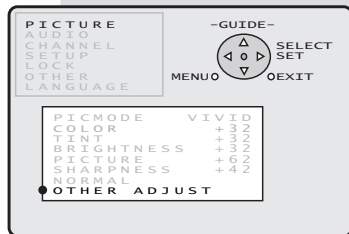

Press  to access OTHER ADJUST sub-menu.

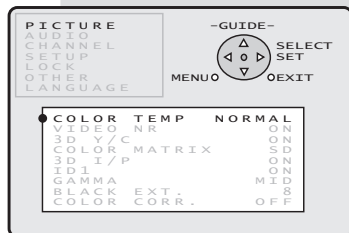

Continued in right column.

Continued from left column.

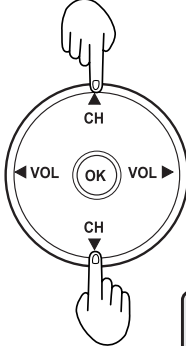
Press  to select desired sub-menu items.

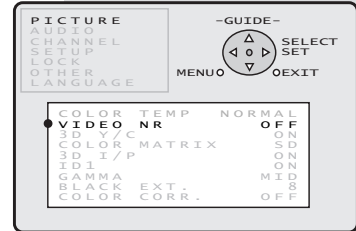

Press  to set or adjust desired menu item.

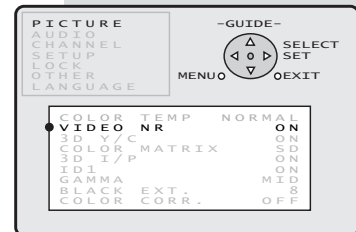

Note: To EXIT menus.

Press **MENU**  repeatedly until normal picture is displayed.



Press **EXIT**  to return to normal picture.



Tuning channels

Automatic channel setting

Automatically searches and adds receivable channels to memory.



Press the MENU button to display the MENU screen.

1

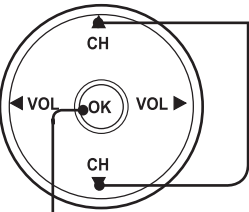

Press to select CHANNEL.

Press to display the CHANNEL screen.

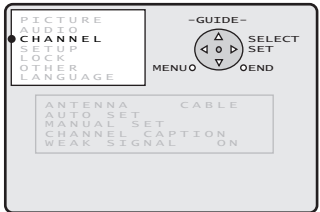

2

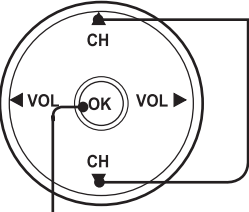

Press to select ANTENNA.

Press to select TV or CABLE.

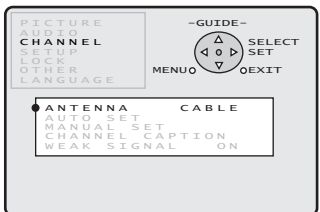

3

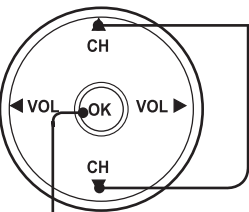

Press to select AUTO SET.

Press to run AUTO SET.

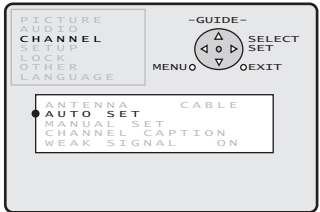

Note:
• To cancel AUTO SET in progress, press the EXIT button.

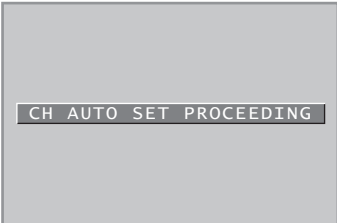

Channels will automatically advance until all channels have been scanned. Channel numbers with a video signal present will be stored in the channel scan memory.

Continued on the next page.

Note:
• TV or Cable Tuning mode must be set according to your connections.

4

Case 1

When setup is complete, the lowest channel picture appears.

Case 2

If setup is incomplete, the screen at right appears. Check connection of Antenna/Cable to the RF in Terminal, then try Automatic Channel Setting again.



5

EXIT



Press to exit menu.

Notes:

- After AUTO SET is finished, the lowest channel number added will be received.
- Some channels with very weak signals may be locked into memory. If desired, these channels can be deleted manually using the MANUAL SET feature.

Tuning channels

Manual channel setting

Use this setting when changing setting of receiving channels or changing the channel display.



Press the MENU button to display the MENU screen.

1

Press to select CHANNEL.

Press to display the CHANNEL screen.

2

Press to select ANTENNA.

Press to select TV or CABLE.

3

Press to select MANUAL SET.

Press to display the MANUAL SET screen.

Continued on the next page.

4 To add channel

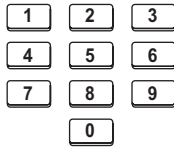

Press to select channel.

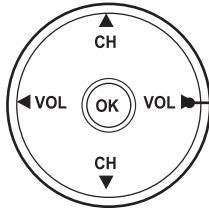

Press to add channels to memory.

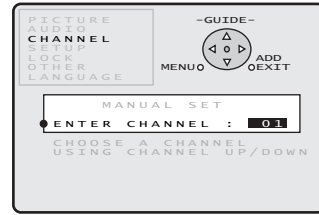

To delete channel

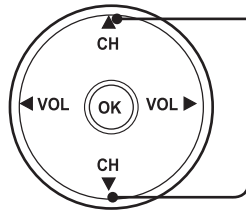

Press to select channel.

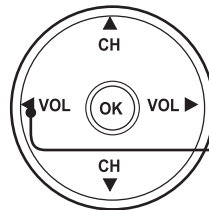

Press to delete channels from memory.

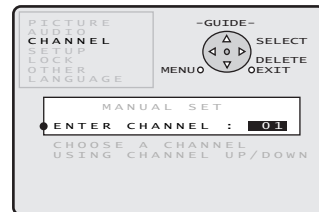

5 Repeat step 4 to continue adding or deleting channels.

6  Press to exit menu.



Note:

- Some channels with very weak signals may be locked into memory. If desired, these channels can be deleted manually using the MANUAL SET feature.

Projection display operation

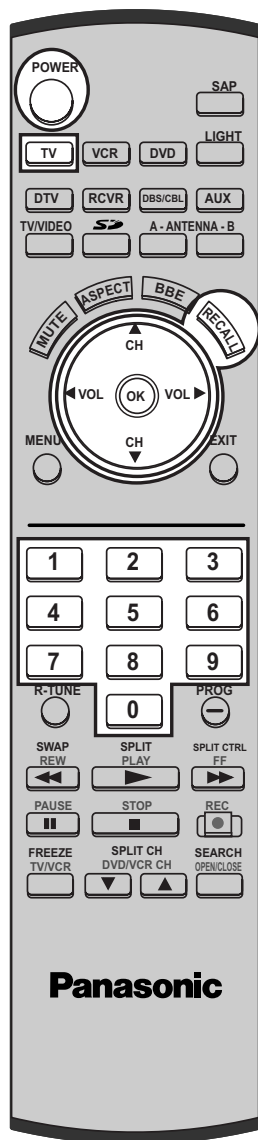
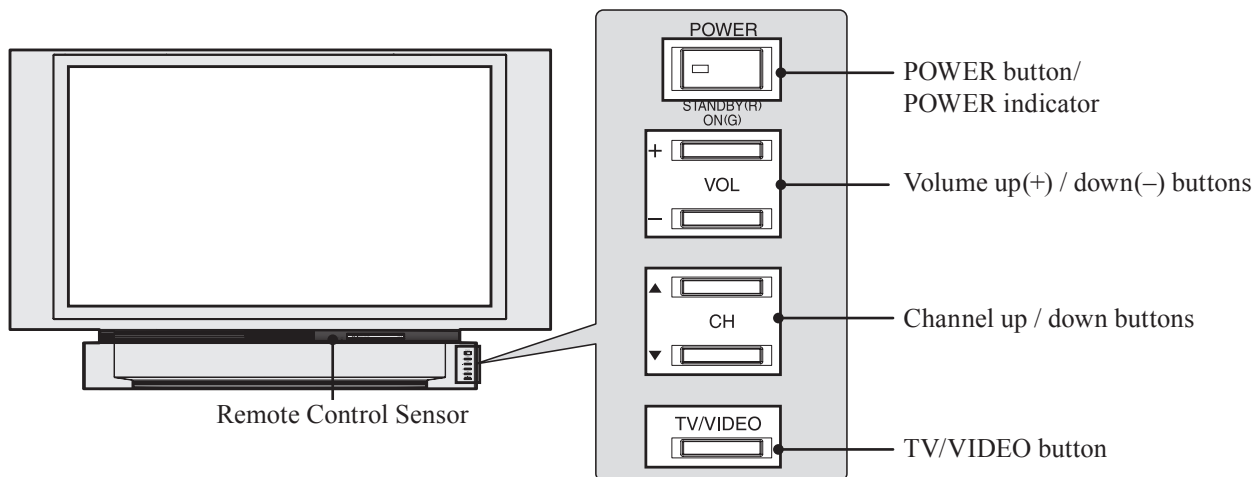
Operation can be done from the projection display.



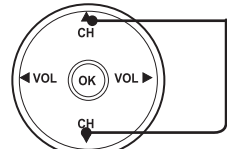

- 1  Press to operate the projection display with the Remote Control.
- 2  Press to turn the projection display on.
- 3  Remote Control
Press to select the desired channel. (Or use Number keys)

Or

1	2	3
4	5	6
7	8	9
0		

Note:

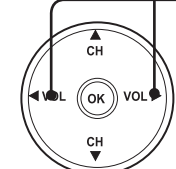
- Refer to "Using the Number keys" on the next page.

- 4  Unit
Press to select the desired channel.
 Press to select the desired volume level.



Notes:

- The channel number and volume level are stored even after the projection display is turned off.
- Power consumption can be reduced if the volume level is lowered.

Projection display operation

TV status display



Press the RECALL button, except when the MENU screen is displayed, to display current TV status information.

Aspect types (P. 32)
Receivable broadcast types (P. 37)

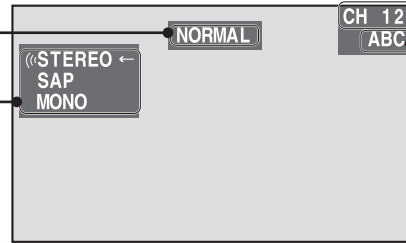

Channel (P. 53)
Channel caption (P. 53)

Using the Number keys

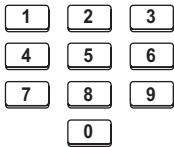

When selecting CABLE channels 100 to 125 with the Number keys, first press the 1 key, and then enter the remaining two digits.

Example 1: To select channel 125, first press the 1 key, then 2, then 5.

Example 2: To select channel 12, press the 1 key, then 2. Channel 12 appears momentarily.

Example 3: To select channel 8, press the 8 key. Channel 8 appears momentarily.

Auto shut off

To extend lamp life, if there is no signal to the set's tuner for 5 minutes, the lamp will shut off automatically.

Invalid operation notification

If an invalid operation is attempted, the mark shown right is displayed.



Example: Invalid operation was tried during FREEZE mode.

ASPECT Controls

The color monitor will allow you to enjoy viewing the picture at its maximum size, including wide screen cinema format picture.



The aspect mode changes each time the ASPECT button is pressed.

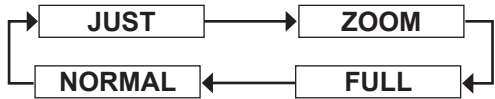

- When a 480p signal is being received, the mode switches between NORMAL, ZOOM, and FULL only.



- During PC input, the mode switches between NORMAL and FULL only.

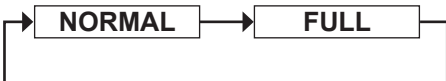

Notes:

- When a 1080i or 720p signal is being received, the mode is set to FULL, and aspect switching is not possible.

Notes:

- However, if the mode selected does not match the aspect ratio of the input signal, the original picture quality may be affected.
- If using this projection display in places, such as cafes or hotels, with the aim of displaying programs for a commercial purpose or for public presentation, please note that by using the aspect ratio (16:9) selection function to change the aspect ratio, you may be infringing on the rights of the original copyright owner of that program under copyright protection laws.
- If a normal (4:3) picture is projected in wide screen, distortion may occur around the edges so that part of the picture may no longer be visible. We recommend viewing in 4:3 mode so you can enjoy the picture as it was intended to be seen.

ASPECT Controls

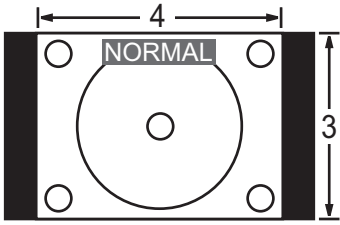
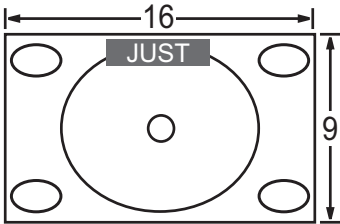
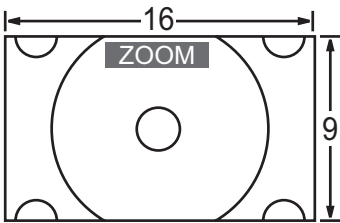
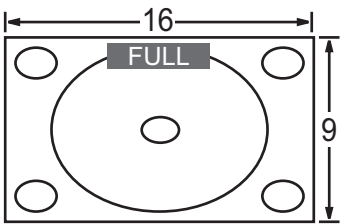
Mode	Picture	Explanation
<p>NORMAL</p>	 <p>The diagram shows a central circle with a smaller inner circle. The width is labeled as 4 and the height as 3. The word 'NORMAL' is written in a box above the circle. There are four small circles at the corners of the frame.</p>	<p>NORMAL will display a 4:3 picture at its standard 4:3 size.</p>
<p>JUST</p>	 <p>The diagram shows a central circle with a smaller inner circle. The width is labeled as 16 and the height as 9. The word 'JUST' is written in a box above the circle. There are four small circles at the corners of the frame.</p>	<p>JUST mode will display a 4:3 picture at maximum size but with aspect correction applied to the center of the screen so that elongation is only apparent at the left and right edges of the screen. The size of the picture will depend on the original signal.</p>
<p>ZOOM</p>	 <p>The diagram shows a central circle with a smaller inner circle. The width is labeled as 16 and the height as 9. The word 'ZOOM' is written in a box above the circle. There are four small circles at the corners of the frame.</p>	<p>ZOOM mode magnifies the central section of the picture.</p>
<p>FULL</p>	 <p>The diagram shows a central circle with a smaller inner circle. The width is labeled as 16 and the height as 9. The word 'FULL' is written in a box above the circle. There are four small circles at the corners of the frame.</p>	<p>FULL will display the picture at its maximum size but with slight elongation.</p>

Note:

- The screen size changes if ID1 is detected. (P. 58)

Searching for the desired channel (Channel search)

Channel search displays each channel, in order, as a paused image. Channels are displayed from the left top to the right bottom in order. When it reaches the right bottom, the next channel is displayed at the left top, overwriting the previously displayed channel.

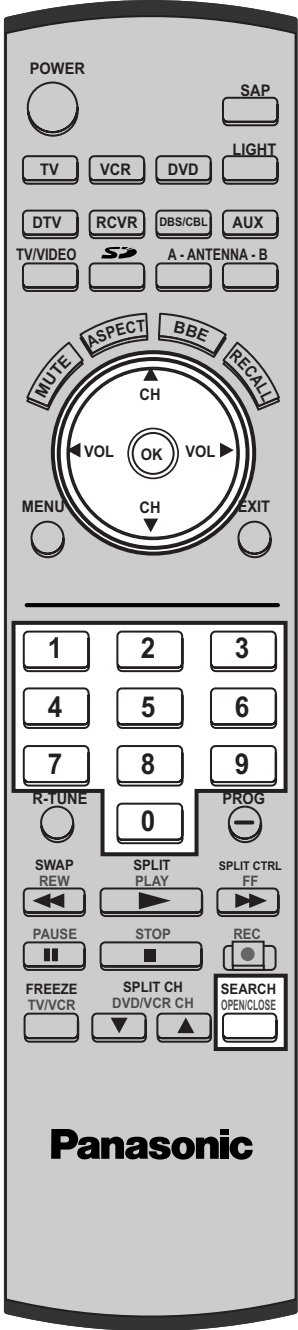

When the SEARCH/OPEN/CLOSE button is pressed during single screen.



Example

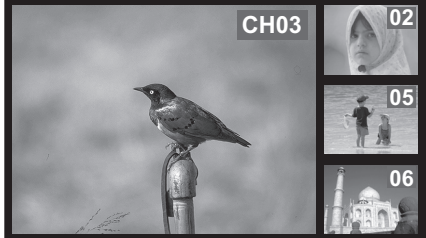

When a channel button is pressed during channel search.

Number keys:
Example: When 6 is pressed, channel 6 is displayed in single screen.

Channel up and down buttons:
When ▲ or ▼ button is pressed, the next channel up or down is displayed in single screen.

Example: Select channel 6

Sound from the left screen is output from the speakers on the projection display set.



Note:
• To end channel search, press SEARCH/OPEN/CLOSE.

Playing peripheral equipment

Confirming connections

A video camera uses the Input 3 terminal on the front of the projection display.

Example: Connect Input 3

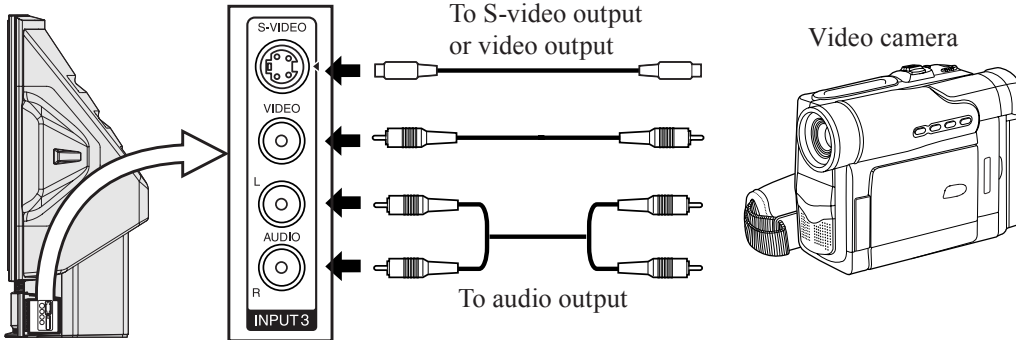

VCR

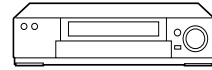

DVD player

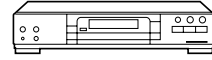

This equipment can also be connected to the rear terminals. See Connections for details.



Turning the power on and switching input modes

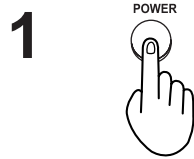

Turn the projection display on.

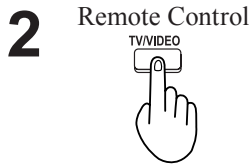

Remote Control

The input mode changes each time this button is pressed.

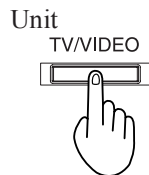

Unit

* If SKIP is set as the Input Label setting of SETUP, the mode will not be changed. (P. 52)



Card input mode is selected.

• Pressing SD again exits Card input mode.

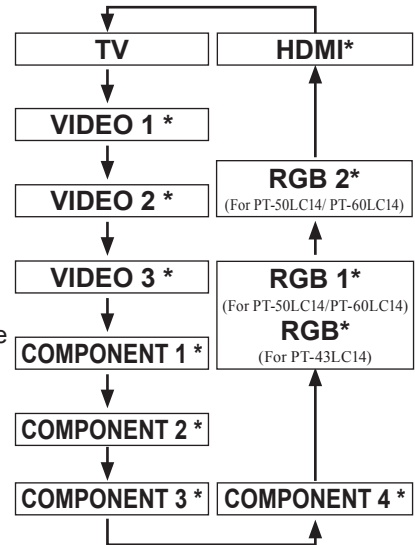

VIDEO 1	Signal of source connected to INPUT 1 is displayed.
VIDEO 2	Signal of source connected to INPUT 2 is displayed.
VIDEO 3	Signal of source connected to INPUT 3 is displayed.
COMPONENT 1	Signal of source connected to COMPONENT VIDEO INPUT 1 is displayed.
COMPONENT 2	Signal of source connected to COMPONENT VIDEO INPUT 2 is displayed.
COMPONENT 3	Signal of source connected to COMPONENT VIDEO INPUT 3 is displayed.
COMPONENT 4	Signal of source connected to COMPONENT VIDEO INPUT 4 is displayed.
RGB 1 (or RGB)	Signal of source connected to RGB IN 1 (or RGB IN) is displayed.
RGB 2	Signal of source connected to RGB IN 2 is displayed.
HDMI	Signal of source connected to HDMI IN is displayed.
CARD	Signal of source connected to CARD SLOT is displayed.

3 Operate the connected equipment.

Mute / Freeze / SAP



Sound mute



Useful when answering the phone or receiving unexpected visitors

Press this button to mute the sound. Press again to reactivate sound. Sound is also reactivated when power is turned off or volume level is changed.

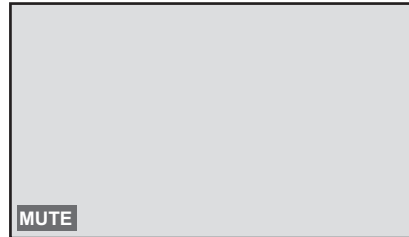

Note:

- The audio output from AV OUT is not muted.

Freezing pictures

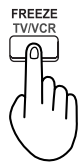

Projection can be switched between a frozen (still) picture and a moving picture each time the FREEZE button on the Remote Control unit is pressed. Press FREEZE button again to resume motion.



Note:

- The video output from AV OUT is not frozen.

Receivable Broadcast Types

The following are possible broadcast types with their accompanying on-screen displays. The signal being received is indicated with a “⌘” mark while the selected audio mode is indicated with an arrow. To change the audio mode for these broadcasts, follow the “Select Audio Mode for TV Viewing” section (below.)

MTS Stereo and SAP broadcast

Multi-channel Television Sound Stereo (main language) and Secondary Audio Program (sub language) broadcasts are both being received simultaneously. Select the STEREO or SAP audio mode.

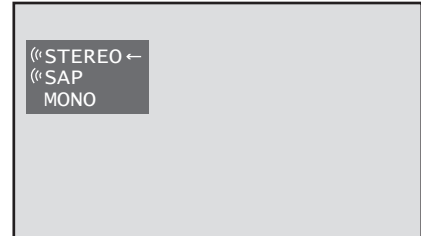

MTS Stereo broadcast

Multi-channel Television Sound Stereo broadcast. Select STEREO audio mode.

- If stereo broadcast is weak and the display flickers, select MONO audio mode for possibly better results.

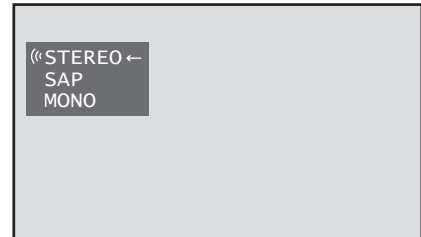

SAP broadcast

Secondary Audio Program (sub language.)
Select SAP audio mode for the sub language.

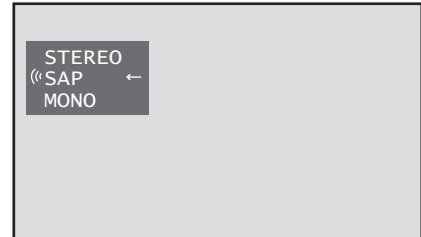

MONO broadcast

Normal monaural sound broadcast.

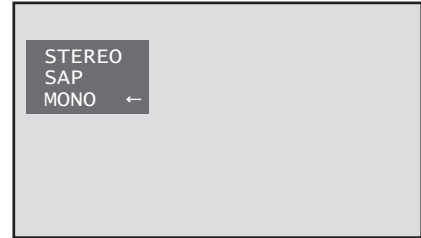

Select Audio Mode for TV Viewing



Press SAP button to select the desired audio mode as described below.
(Arrow shows selection.)

- Each press of SAP button will change the audio mode as shown below.
- “SAP” is selected with first press of SAP button.

Example:

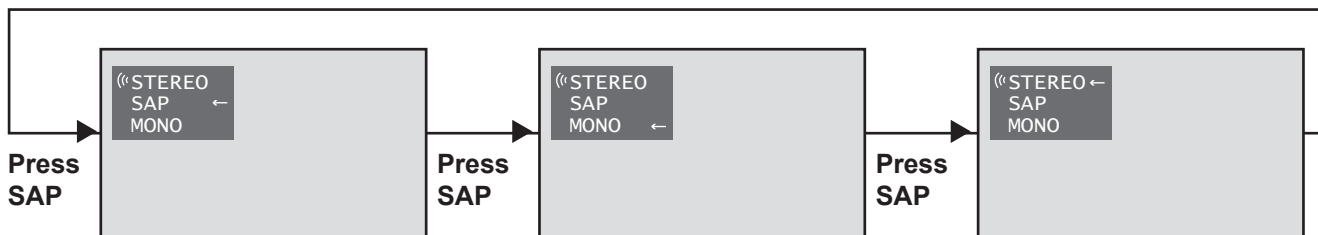

Split screen



Splitting the screen



Press to split.
(The previously selected screen appears on the left.)

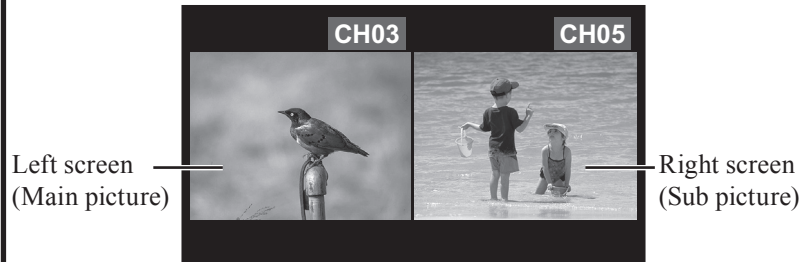

Returning to one screen



Press to return.

Notes:

- Sound from the Left screen is output from the speakers on the projection display set.
- When the screen is split, signals of the Left screen are output from the rear monitor output terminal.
- The left and right screens are processed by individual circuits and, therefore, may vary in image quality.
- Split screen returns to single screen when the projection display is turned off.
- With the Left screen, as with a single screen, you can change the input, change channels, and adjust the volume.
- The right and left screens cannot display the same picture at the same time.
- CARD input screen cannot be displayed using the Split Screen function.
- When viewing a split screen with HDMI as the input signal of the Left screen, if the HDMI signal is incompatible (see P. 21) or is nonexistent, the entire screen will go black and "SIGNAL" will be displayed.

Changing the channel of the right screen

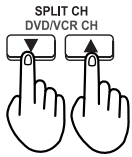

Press to select the desired channel.

Example:
During SPLIT SCREEN NORMAL



SPLIT CH ▲, ▼ buttons can also be used to select an outside input for the right side of the screen.

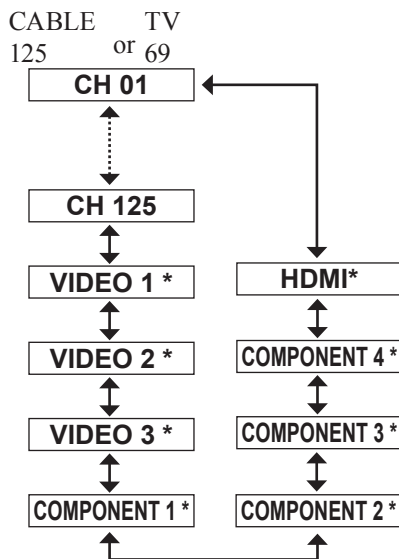

* If SKIP is set as the Input Label setting of SETUP, the mode will not be changed. (P. 52)

Note:

- When outside input is finished, the lowest registered channel number is displayed. For faster selection, press the SWAP button to change the screen to the left. Then, press the TV/VIDEO button to directly change the input. Finally, press SWAP button again to change the screen back to the right.

Swapping left and right screens



Press to swap.

Example:
During SPLIT SCREEN NORMAL

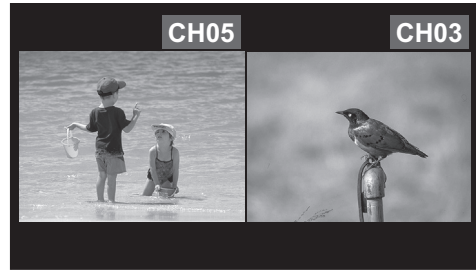

Note:

- Picture quality may change according to the combination of signals input to the left and right screens.

Adjusting screen position and size



1  Press to select the screen mode.

2 Press the MENU button to display the MENU screen.

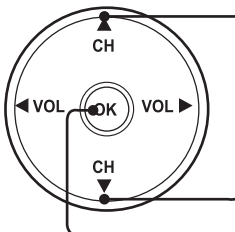
 Press to select OTHER.

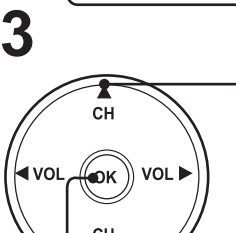
 Press to display OTHER screen.

3  Press to select POSITION/SIZE.

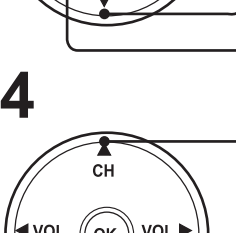
 Press to display POSITION/SIZE sub-menu.

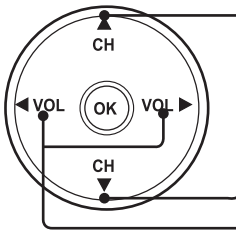
4  Press to select each item.

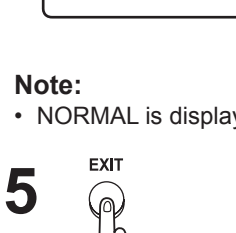
 Press to set or adjust to desired level. (See next page.)

Note:

- NORMAL is displayed at default.

5  Press to exit menu.

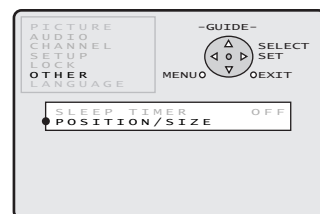
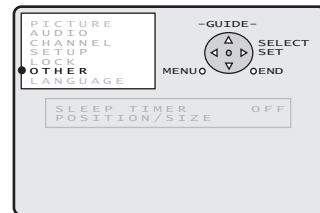

JUST mode

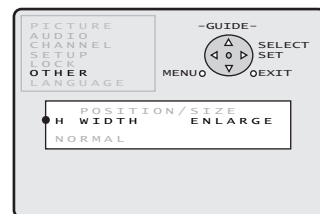

NORMAL mode

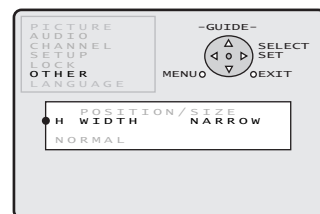

RGB input

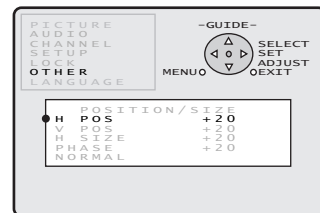

ZOOM mode

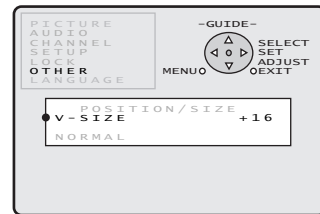

Adjusting screen position and size

Adjustment item	Button	Adjustment Details	Note
H Position	Press ► button.	The image moves to the right.	PC input
	Press ◀ button.	The image moves to the left.	
V Position	Press ► button.	The image moves up.	PC input
	Press ◀ button.	The image moves down.	
H WIDTH	Press OK button.	If noise appears on the ends of the image in SHRINK, switch to ENLARGE.	Only JUST mode
		If noise appears on the ends of the image in WIDEN, switch to NARROW.	
V SIZE	Press ► button.	Press to enlarge image vertically.	Only ZOOM mode
	Press ◀ button.	Press to shrink image vertically.	
H SIZE	Press ► button.	Press to enlarge image horizontally.	PC input
	Press ◀ button.	Press to shrink image horizontally.	
PHASE	Press ► button. Press ◀ button.	Adjust in order to remove any picture interference or contour blurring which may occur in computer images.	PC input

Notes:

- This projection display is equipped with various screen modes. If a screen mode with a different aspect from the broadcast program is selected, image will appear differently. Select the proper screen mode with this in mind.
- Be careful when using this projection display for commercial purposes or for public use, such as in cafes and hotels.
- Shrinking and enlarging images by using screen mode switching function (zoom, etc.) may violate copyright laws.
- Images displayed on a wide screen TV will be cut off or distorted at the edges, when viewing normal aspect images of 4:3 in ZOOM, JUST or FULL mode. Display in NORMAL mode to view the original image intended by the producer.
- For 1080i and 720p input images, screen size cannot be adjusted.
- The adjusted setting will be kept even when the projection display is turned off.
- The signals output from the monitor output terminal on the back of the projection display is not affected when the screen size and position is adjusted.

Audio Adjustments



Panasonic

Press the MENU button to display the MENU screen.

1

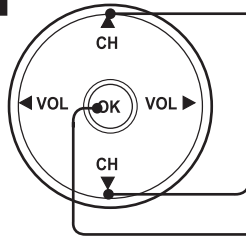

Press to select AUDIO.

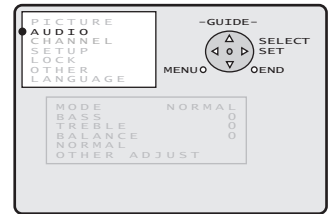

2

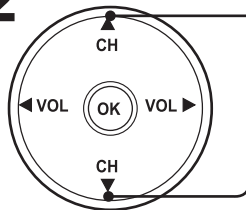

Press to display AUDIO screen.

Press to select each item.

Note:

- NORMAL is displayed at default.

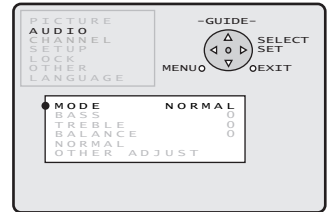

3

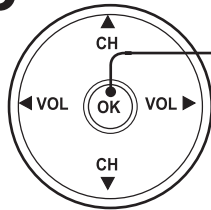

Press repeatedly to select MODE.

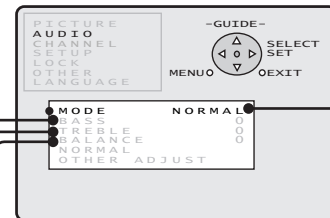

BALANCE:

Emphasize the left/right speaker volume.

TREBLE:

Increase or decrease the treble response.

BASS:

Increase or decrease the bass response.

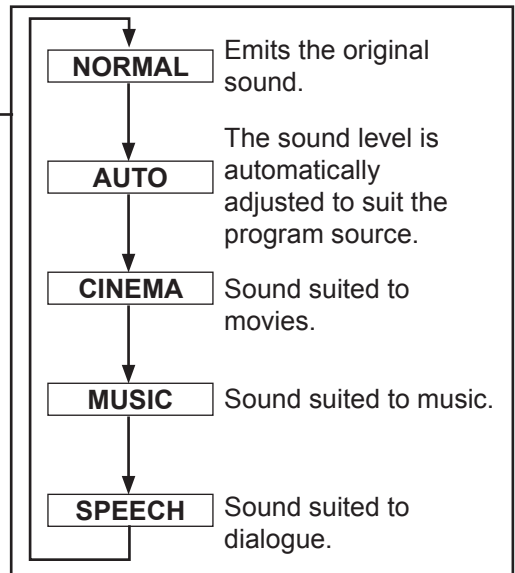

NORMAL Emits the original sound.

AUTO The sound level is automatically adjusted to suit the program source.

CINEMA Sound suited to movies.

MUSIC Sound suited to music.

SPEECH Sound suited to dialogue.

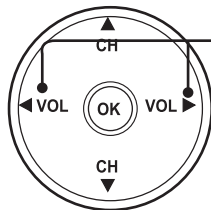

Adjust to desired level while viewing picture through the menu overlay. Press the MENU button or wait a few seconds to return to the previous menu screen.



Continued on next page.

OTHER ADJUST

While in the AUDIO menu screen, select OTHER ADJUST and press the OK button to display the OTHER ADJUST sub-menu.

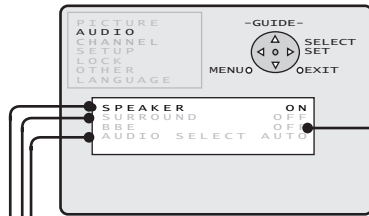

BBE:
Natural sound is offered. (See below.)

AUDIO SELECT (HDMI input only):

Perform input switching of analog audio input and digital audio input when using the HDMI terminal.
AUTO : Automatically performs digital/analog input switching according to the input signal type.
Digital in : Forces use of digital audio input signal transmitted via the HDMI terminal.
Analog in : Forces use of analog audio input signal transmitted via separate RCA terminals.

SURROUND:

Enhances audio response when listening to stereo.

SPEAKER:

This feature is used to turn TV speakers ON or OFF.

- ON: TV speakers operate normally.
- OFF: TV speakers off.

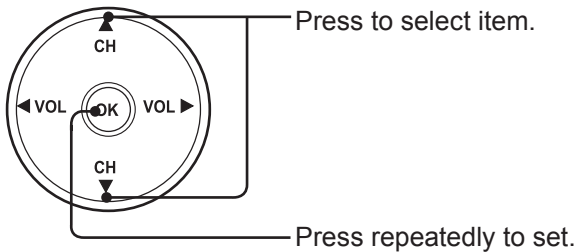

Press to select item.

Press repeatedly to set.

4



Press to exit menu.

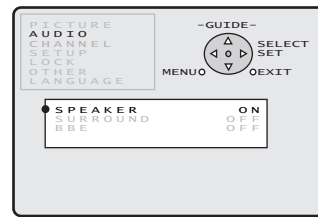

HDMI input

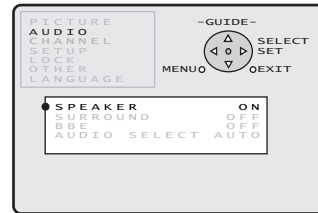

Using BBE button.



BBE VIVA 3D - BBE VIVA provides a musically accurate natural 3D image with hi-fi sound. The clarity of the sound is improved by BBE while the width, depth and height of the sound image are expanded by BBE's proprietary 3D sound processing. BBE VIVA is compatible with all TV programs including news, music, dramas, movies and sports as well as electronic games. BBE VIVA enhances the surround sound effect, while maintaining the clarity of dialogue.

BBE - Sound technology enhances speech intelligibility and restores the dynamic range of musical passages to provide outstanding natural sound.

Note:

- If BBE is ON, SURROUND cannot be selected.

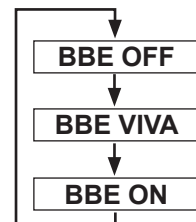

Notes:

- Sound signals are output from the rear AUDIO OUT terminal.
- When volume is adjusted or the mute button is pressed from the Remote Control, a message will be displayed.
- If the AUDIO MENU is set to AUTO, or if BBE is ON, BASS and TREBLE cannot be adjusted.

Picture Adjustments



Press the MENU button to display the MENU screen.

1

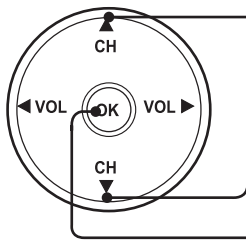

Press to select PICTURE.

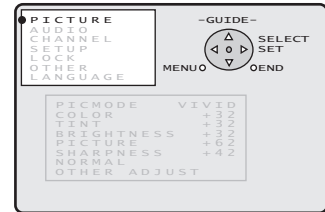

Press to display PICTURE screen.

2

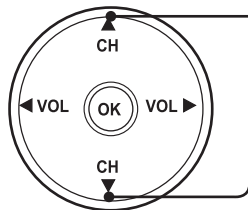

Press to select each item.

Note:

- NORMAL is displayed at default.

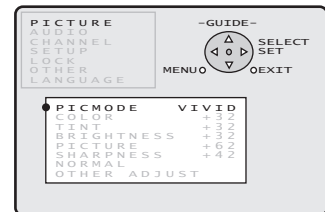

3

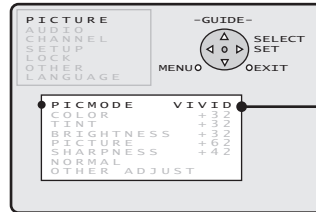

PICMODE:

Lets you choose one of three pre-set Picture Modes that best suits the program you are viewing. Selecting this feature will also affect Color Temperature setting.

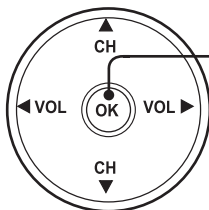
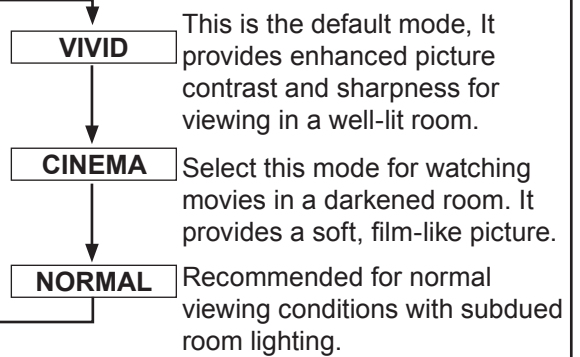

Press repeatedly to select PICMODE.

Note:

- There is little change when PICTURE is increased with a bright picture or reduced with a dark picture.

Continued on next page.

Picture Adjustments

COLOR
TINT
BRIGHTNESS
PICTURE
SHARPNESS

Adjust to desired level while viewing picture through the menu overlay. Press the MENU button or wait a few seconds to return to the previous menu screen.

4 Press to exit menu.

Adjustment item	Button	Adjustment Details
COLOR	Press ► button.	The color becomes deeper.
	Press ◀ button.	The color becomes paler.
TINT	Press ► button.	Flesh tones become greenish.
	Press ◀ button.	Flesh tones become reddish.
BRIGHTNESS	Press ► button.	The screen becomes brighter.
	Press ◀ button.	The screen becomes darker.
PICTURE	Press ► button.	Picture intensity becomes stronger as both contrast and color levels are adjusted.
	Press ◀ button.	Picture intensity becomes weaker as both contrast and color levels are adjusted.
SHARPNESS	Press ► button.	The picture quality becomes sharper.
	Press ◀ button.	The picture quality becomes softer.

Lock Feature

This projection display has a built-in V-Chip Control which allows you to block unwanted TV usage based on US MOVIES and US TV PROGRAMS ratings.

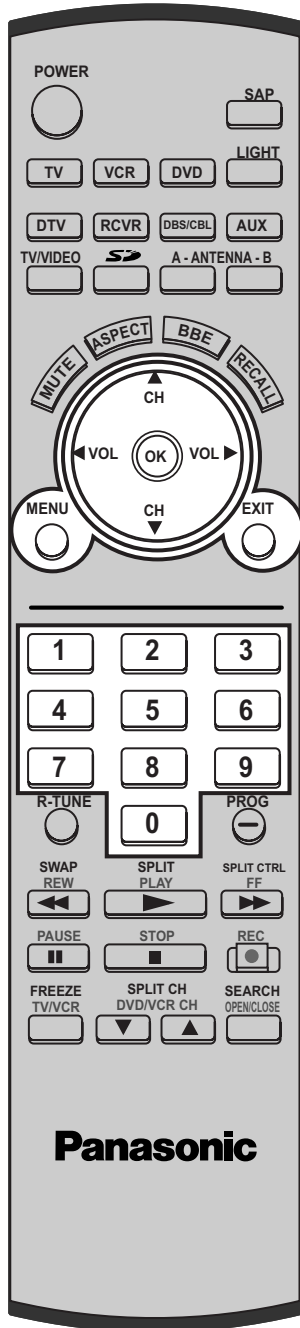

Notes:

- Once ratings are set, restricted tapes or programs cannot be accessed unless the secret code is entered.
- If you forget your secret code, refer to "Reset User's Memory Functions" on page 49.

Enter Secret Code

A 4-digit code must be entered to view a blocked program or change rating settings.

Press the MENU button to display the MENU screen.

1 Press to select LOCK.

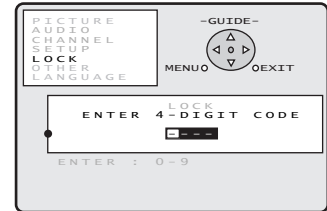

Press to display the LOCK screen.

2 Press Number keys to enter your secret code.

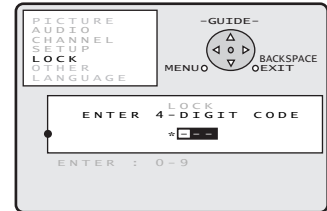

Note:
• To correct, press "◀" to backspace.

Press to save 4-digit code.

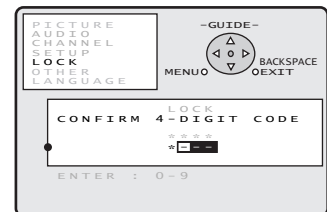

Changing your secret code

- You will need your current code. With the OSD at right displayed, press "◀" to clear the current code. Repeat step 2 to enter a new code.

Note:

- Use a code that is easy to remember and record it in a safe place.

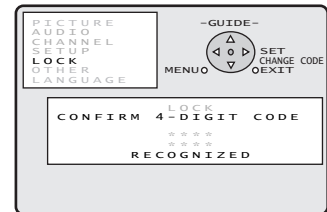

3 Press to exit menu.

Or,

Press to display LOCK menu for rating screen and go to page 47 (US MOVIES Ratings), or page 48 (US TV PROGRAMS Ratings).

Setup US MOVIES Ratings

Perform "Enter Secret Code" step 1 on page 46.

1

1	2	3
4	5	6
7	8	9
0		

Press Number keys to enter your secret code.

+

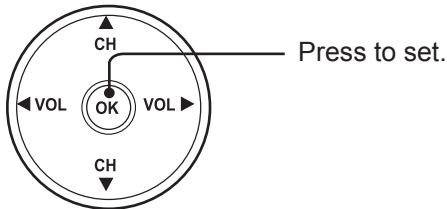

2

Press to select US MOVIES.

ON: V-Chip Control is activated.
OFF: V-Chip Control is deactivated.

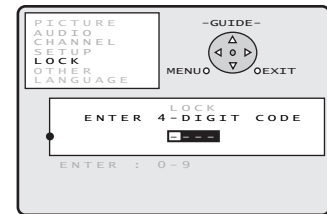

3

Press to select CHANGE SETTINGS.

Press to display the CHANGE SETTINGS screen.

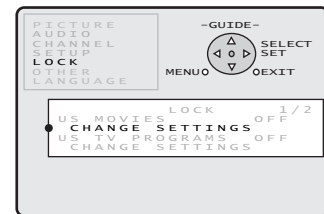

4

Press to select VIEW NR PROGRAMS?.

Press to set "YES" or "NO".

VIEW NR (Not Rated) PROGRAMS
NO: Cannot view NR programs.
YES: Can view NR programs.

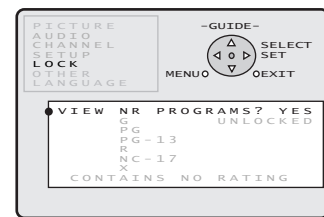

5

Press to select ratings to be blocked. (P. 49)

Press to set.

Note:

- Ratings highlighted in Red will be blocked while those not highlighted (black letters) will not be blocked.

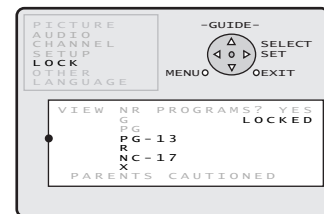

6

Press to exit menu.

Lock Feature



Setup US TV PROGRAMS Ratings

Perform "US MOVIES Ratings" step 1 on page 47.

1 Press to select US TV PROGRAMS.

Press to set.

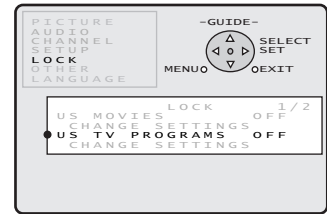

ON: V-Chip Control is activated.
OFF: V-Chip Control is deactivated.

2 Press to select CHANGE SETTINGS.

Press to display the CHANGE SETTINGS screen.

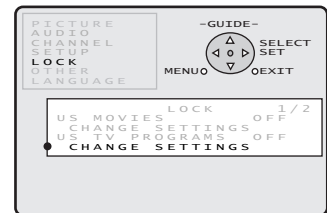

3 Press to select VIEW NR PROGRAMS?.

Press to set "YES" or "NO".

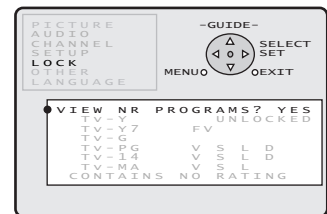

VIEW NR (Not Rated) PROGRAMS

NO: Cannot view NR programs.

YES: Can view NR programs.

4 Press to select ratings to be blocked. (P. 49)

Press to set.

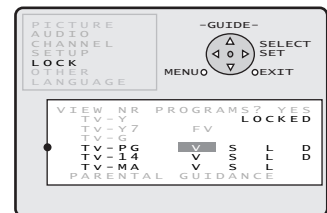

You may select from standard TV ratings (chart 1), or customize to a specific content rating (chart 2.)

Note:

- Ratings highlighted in Red will be blocked while those not highlighted (black letters) will not be blocked.

5 Press to exit menu.

US MOVIES RATINGS:

G	GENERAL AUDIENCE: All ages admitted.
PG	PARENTAL GUIDANCE SUGGESTED: Some materials may not be suitable for children.
PG-13	PARENTS CAUTIONED: Some materials may be inappropriate for children under 13.
R	RESTRICTED Children under 17 must be accompanied by a parent or adult.
NC-17	OVER AGE 17 ONLY: No one 17 and under admitted.
X	ADULTS ONLY:

US TV PROGRAMS RATINGS: Chart 1

TV-Y	FOR ALL CHILDREN: Content specifically geared to young viewers ages 2-6.
TV-Y7	FOR AGE 7 AND OLDER: May contain mild physical or comedic violence which may frighten children under 7.
TV-G	GENERAL AUDIENCE: Contains little or no violence, strong language, or sexual dialogue or situations.
TV-PG	PARENTAL GUIDANCE: May contain infrequent coarse language, limited violence, some suggestive sexual dialogue and situations.
TV-14	PARENTS CAUTIONED: May contain sophisticated themes, sexual situations, strong language, and more intense violence.
TV-MA	MATURE AUDIENCE: May contain mature themes, profane language, graphic violence, and sexual situations.

US TV PROGRAMS RATINGS: Chart 2

FV	Fantasy Violence
V	Violence
S	Sexual Situations
L	Adult Language
D	Sexually Suggestive Dialogue

Blocking Message

<When V-Chip Control is activated>

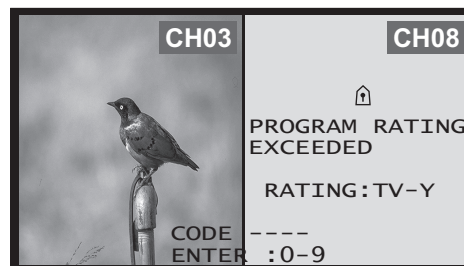
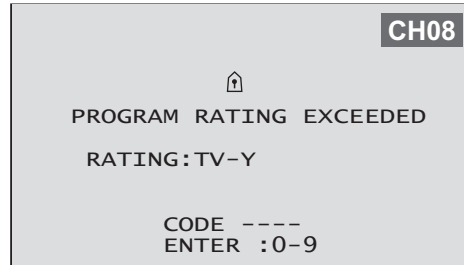

Temporarily deactivate V-Chip control

Enter your secret code in the blocking message screen.

- V-Chip control is reactivated when power is turned off or power failure occurs.

Reset User's Memory Functions

Use when moving unit to a new location, or if the secret code is forgotten.

While the OSD at right is displayed, press the VOL- button on the projection display and OK button on the Remote control at same time for more than 5 seconds. When reset is finished, power shuts off automatically.

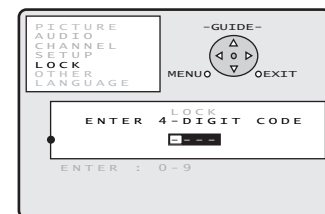

Closed Captions

This receiver has a built in decoder that provides a visual depiction of the audio portion of a television program in the form of written words across the screen (white or colored letters on a black background). It allows the viewer to read the dialogue of a television program or other information.



Note:

- The closed caption or text signal may be broadcast over C1, C2, or both. Also, text contents can vary so you may wish to try different settings.

CAPTION MODE

Activates the On-Screen Closed Caption feature. When activated this feature will remain on until OFF is selected in this menu.

Press the MENU button to display the MENU screen.

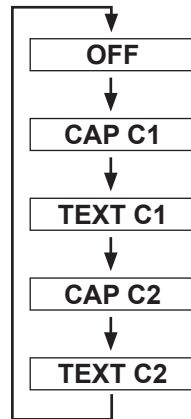
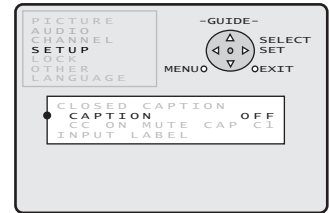
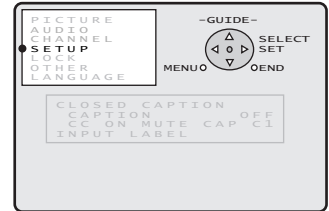
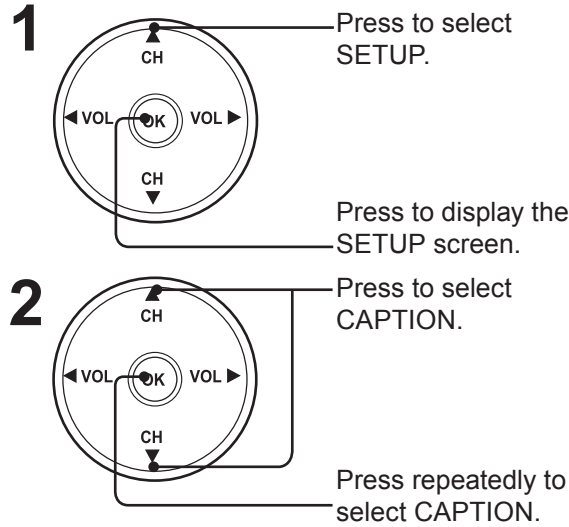

Closed Caption Modes from which to Choose

Caption Mode: CAP C1 or C2

A narration of selected TV programs is displayed. Check TV program listings for C. C. (Closed Caption) broadcasts.

Caption Mode: TEXT C1 or C2

The screen will be blocked out. When the TV station broadcasts information, such as program listings, it will appear in this space.

Caption Mode: OFF

Closed Caption /Text narration will not be displayed.

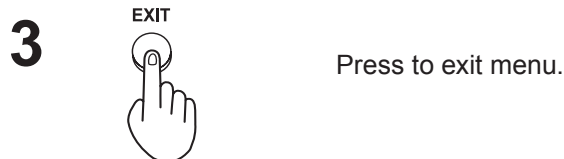

CC ON MUTE

Activates the On-Screen Closed Caption feature, when the MUTE button on the Remote Control is pressed. To deactivate, press the MUTE button again.

Note:

- This feature functions when the Closed Caption Mode is in the "OFF" position. The program being viewed must be broadcast with Closed Caption.

Press the MENU button to display the MENU screen.

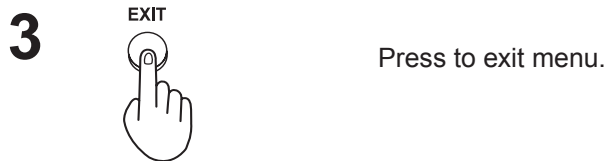
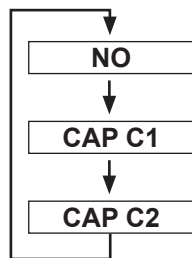
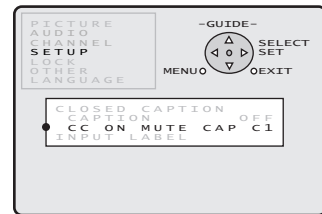
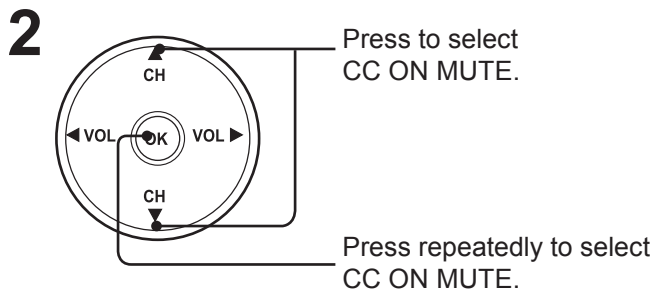
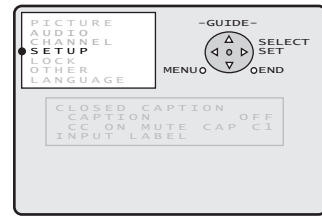
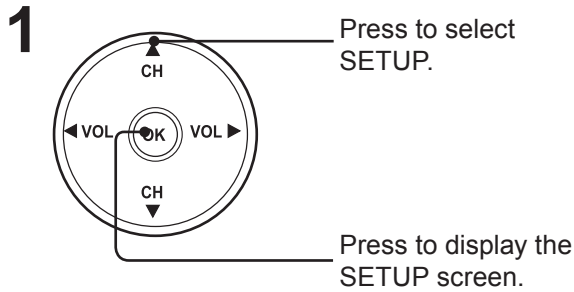

Notes:

- The setting for CC ON MUTE is valid only when the CC MODE is OFF, CC MODE set to ON will override CC ON MUTE.
- Closed Caption is not displayed if the input signal is COMPONENT VIDEO INPUT of 480p or more, or from RGB IN.

Input Label

To label video input connections for on-screen display.



Press the MENU button to display the MENU screen.

1 Press to select SETUP.

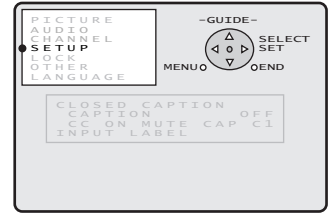
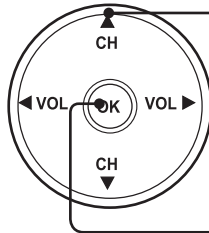

Press to display the SETUP screen.

2 Press to select INPUT LABEL.

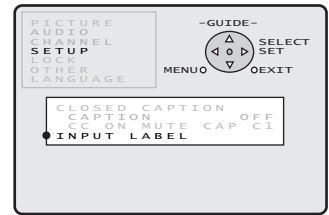
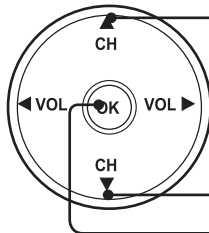

Press to enter INPUT LABEL listed.

3 Press to select inputs.

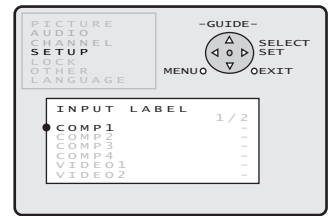
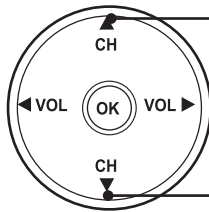

4 Press to select preset Input Labels for inputs.

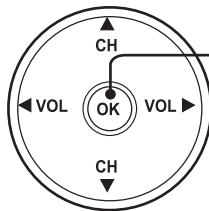

Input Labels that are set to SKIP cannot be selected when changing input modes with the TV/VIDEO button, etc.

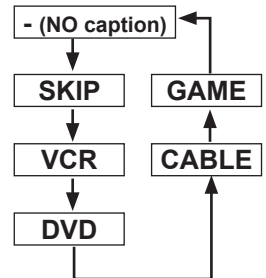

5 Press to select another input, then repeat procedure for adding more labels to inputs.

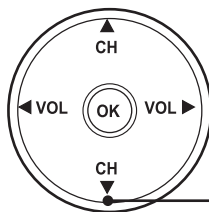

6 Press to exit menu.



Channel Caption Feature

Station names, e.g. ABC, TNN, etc. so that they will appear when a channel is selected. Choose 24 preset names.



Press the MENU button to display the MENU screen.

1

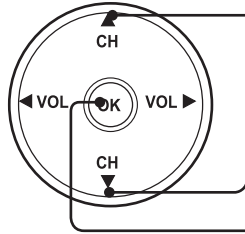

Press to select CHANNEL.

Press to display the CHANNEL screen.

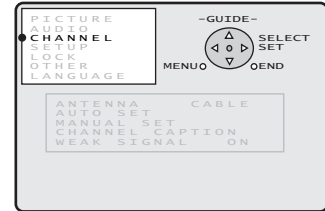

2

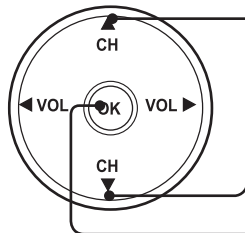

Press to select CHANNEL CAPTION.

Press to display the CHANNEL CAPTION screen.

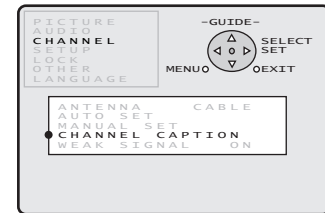

3

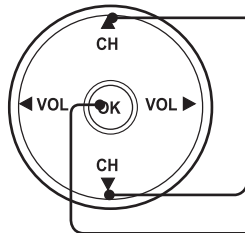

Press to select a station.

Press to move cursor to the right.

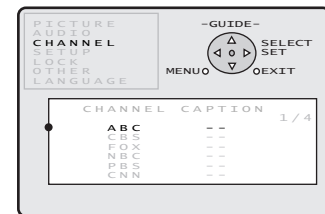

To remove a registered channel number, select the station, then press the ◀ button (CLEAR).

4

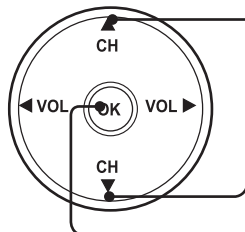

Press to select channel number.

Press to set.

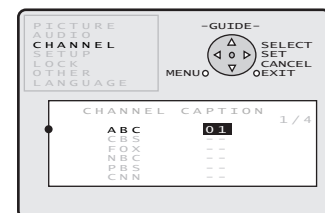

To make a correction, press the ◀ button.

- Repeat steps 3 and 4 until the Caption List is complete.

5



Press to exit menu.

Weak Signal Display Feature

When "ON" is selected, the picture is displayed even when a broadcast signal is weak or non-existent.



Press the MENU button to display the MENU screen.

1

Press to select CHANNEL.

Press to display the CHANNEL screen.

2

Press to select WEAK SIGNAL.

Press to set "ON" or "OFF".

ON: Picture is displayed regardless of signal condition, and may not always be clearly visible.

OFF: Screen turns solid blue when signal is absent or weak. (Screen turns solid black during SPLIT functions.)

3

Press to exit menu.

Note:

- If unit is connected to equipment which has blue back feature, selecting "ON" will have no effect on the other equipment.

Color Temp Feature

To increase or decrease Warm (red) and Cool (blue) colors to suit personal preferences.



Press the MENU button to display the MENU screen.

1

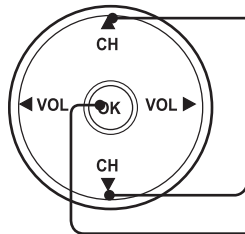

Press to select PICTURE.

Press to display the PICTURE screen.

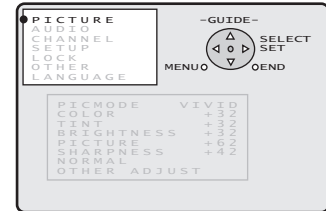

2

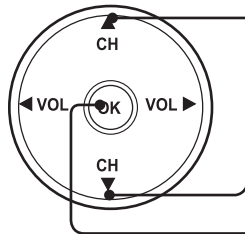

Press to select OTHER ADJUST.

Press to display the OTHER ADJUST screen.

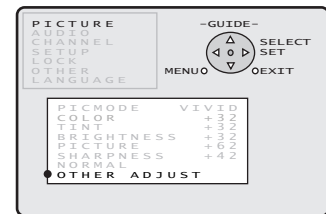

3

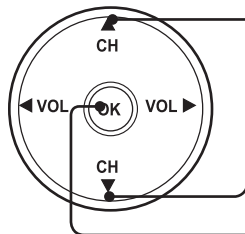

Press to select COLOR TEMP.

Press to set .

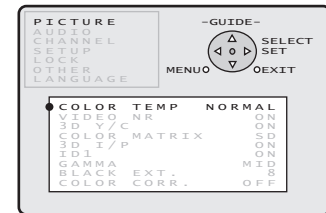

- NORMAL** Normal color
- WARM** Warm color (more red)
- COOL** Cool color (more blue)

4



Press to exit menu.

Note:

- During RGB input, Color Temp changes to Normal.

RGB Level Feature (RGB input only)

If the picture has a reddish or blueish tint, or if the whiteness is not at the desired level, you can adjust the white balance. (The following steps show R Level adjustment.)

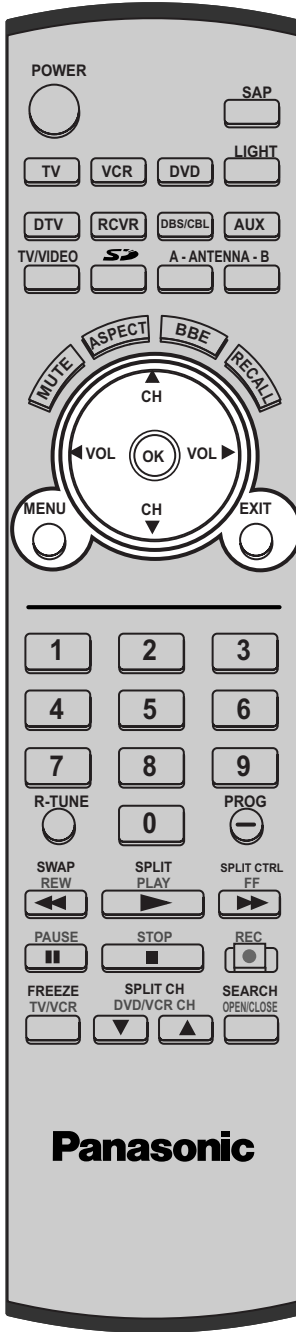

Press the MENU button to display the MENU screen.

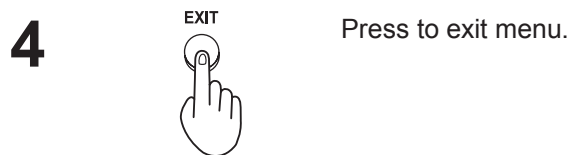
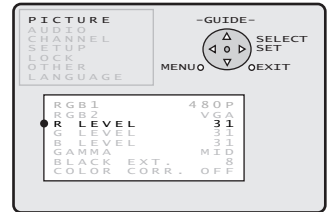
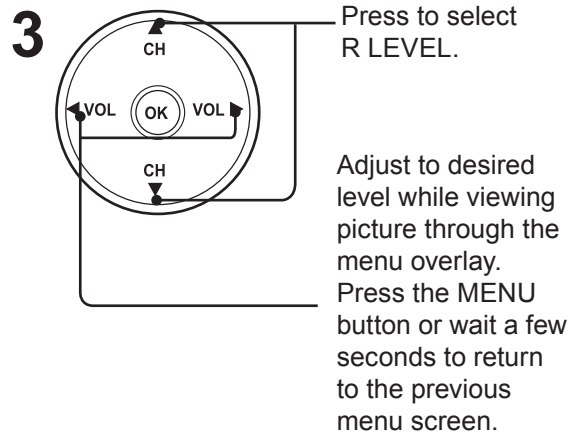
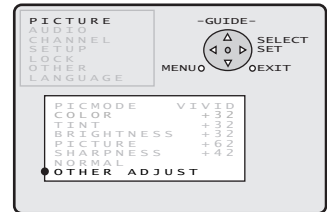
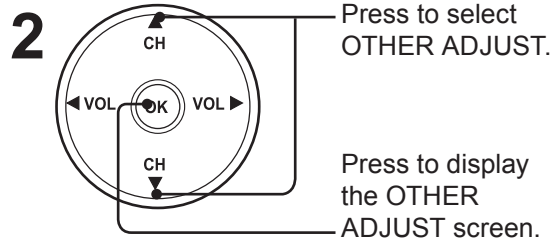
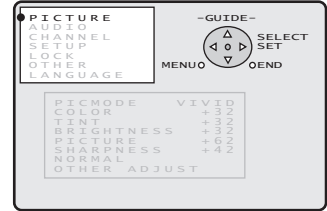
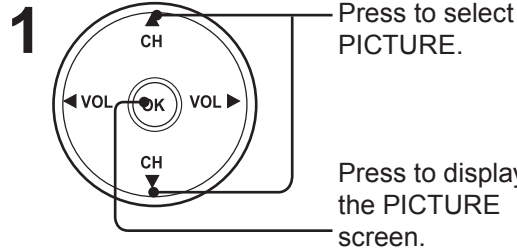

Adjustment item	Button	Adjustment Details	Remarks
R LEVEL	Press ► button.	The red component becomes stronger.	RGB IN only
	Press ◀ button.	The red component becomes weaker.	
G LEVEL	Press ► button.	The green component becomes stronger.	
	Press ◀ button.	The green component becomes weaker.	
B LEVEL	Press ► button.	The blue component becomes stronger.	
	Press ◀ button.	The blue component becomes weaker.	

Note:

- If adjustments are not done correctly, all colors will become abnormal.

Video NR (Noise Reduction) Feature

In the event of weak signal conditions, the Video NR circuitry reduces noise in the luminance channel. It is important to note that Video NR should remain OFF for maximum picture detail when receiving a strong signal or viewing high-quality video.



Press the MENU button to display the MENU screen.

1

Press to select PICTURE.

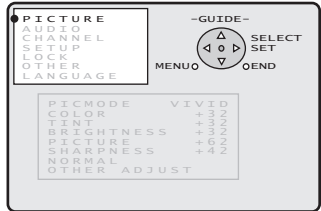

2

Press to display the PICTURE screen.

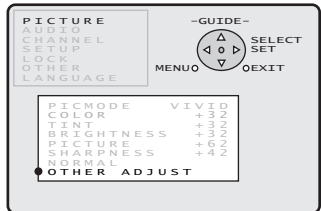

3

Press to select VIDEO NR.

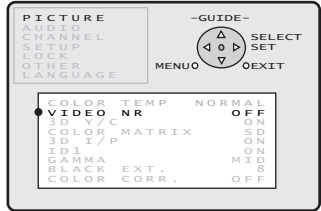

ON: When signal is noisy
 OFF: When signal is high-quality

4

Press to exit menu.

Note:
 • When an RGB signal is input, VIDEO NR is set to OFF only.

Automatically changing screen size

If the received signal contains screen size specifications in RF, VIDEO INPUT (1-3) or COMPONENT VIDEO INPUT (1-4), the screen size is automatically changed.



Press the MENU button to display the MENU screen.

1

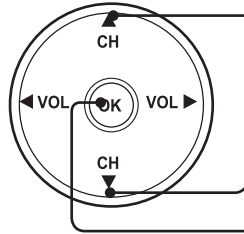

Press to select PICTURE.

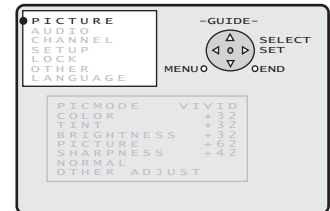

Press to display the PICTURE screen.

2

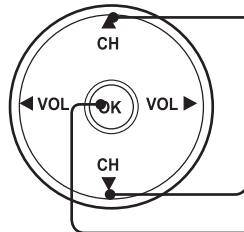

Press to select OTHER ADJUST.

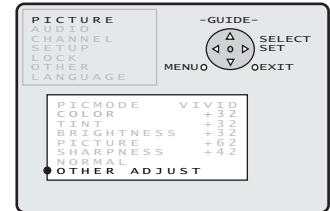

Press to display the OTHER ADJUST screen.

3

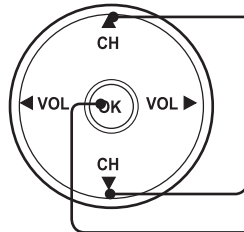

Press to select ID1.

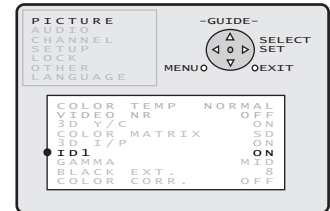

Press to set "ON" or "OFF".

ON: When screen size specification signals are detected, screen size is automatically changed.

OFF: The screen size is not automatically changed. (Turn OFF if this function does not operate properly.)

4



Press to exit menu.

Notes:

- When ID1 is detected and screen size is changed, Aspect mode will be displayed.
- When displaying split screen, ID1 is not detected.

Setting when 480p signals are input through COMPONENT VIDEO INPUT

Adjust 480p signals to achieve a natural color from digital equipment connected to COMPONENT VIDEO INPUT (Y, PB, PR input terminals).



Press the MENU button to display the MENU screen.

1

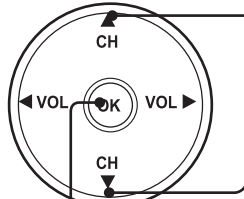

Press to select PICTURE.

Press to display the PICTURE screen.

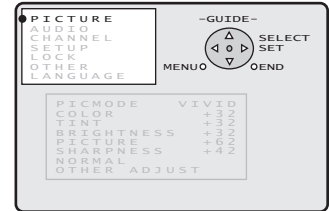

2

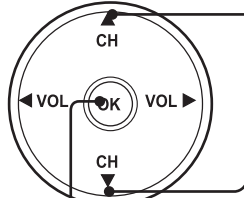

Press to select OTHER ADJUST.

Press to display the OTHER ADJUST screen.

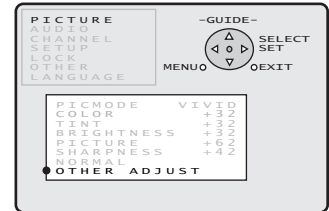

3

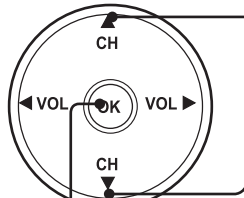

Press to select COLOR MATRIX.

Press to set "SD" or "HD".

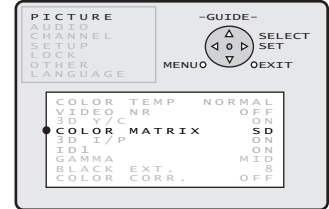

SD : When the input signal is a normal TV system (NTSC).

HD : When the input signal is a High-Definition system (HD).

4



Press to exit menu.

Note:

- 480p COLOR MATRIX does not need to be set when using Hi-Definition equipment or 480i output equipment.

RGB Input Feature

Set the signal to be input to the projection display's RGB IN terminal. Most of analog RGB IN signals are selected automatically. When RGB input signal is VGA 60Hz from PC or 480P from other equipment, you must manually switch to the desired input.



Press the MENU button to display the MENU screen.

1

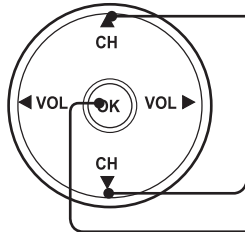

Press to select PICTURE.

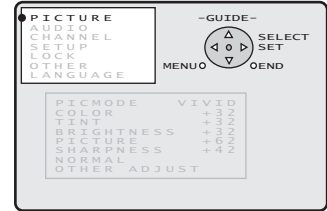

Press to display the PICTURE screen.

2

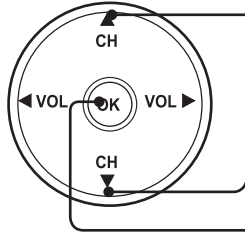

Press to select OTHER ADJUST.

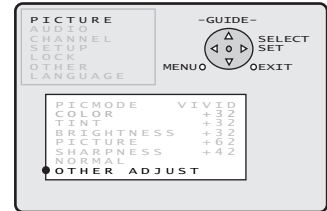

Press to display the OTHER ADJUST screen.

(For PT-50LC14/PT-60LC14)

3

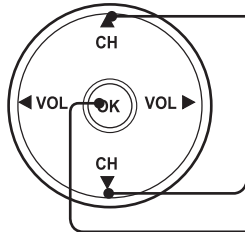

Press to select desired RGB input.

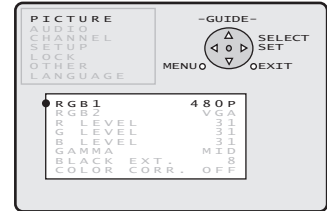

Press to set "VGA" or "480P".

(For PT-43LC14)

VGA : When RGB input signal is VGA 60Hz from PC.

480P : When RGB input signal is 480P from other equipment.

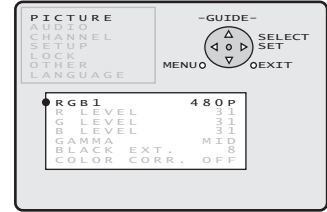

4

EXIT



Press to exit menu.

3D Y/C Feature

Accurate separation of the picture's brightness and color signals allows you to enjoy a beautiful picture.



Press the MENU button to display the MENU screen.

1

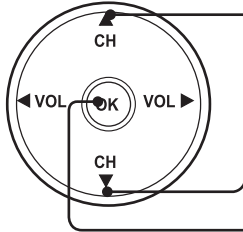

Press to select PICTURE.

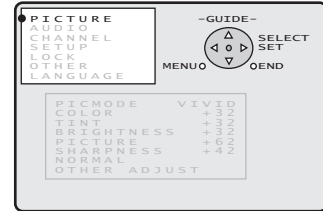

Press to display the PICTURE screen.

2

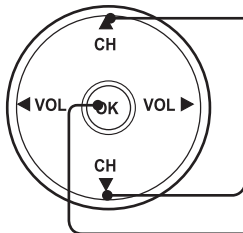

Press to select OTHER ADJUST.

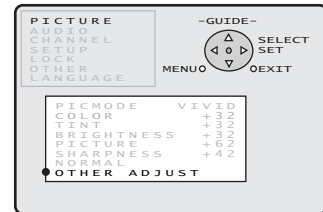

Press to display the OTHER ADJUST screen.

3

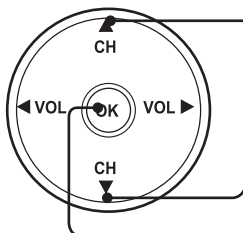

Press to select 3D Y/C.

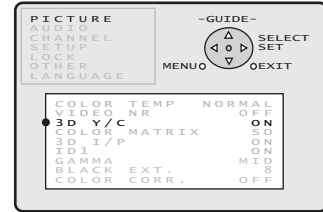

Press to set "ON" or "OFF".

ON: Usually set to ON.

OFF: Set to OFF if picture appears unnatural.

4



Press to exit menu.

3D IP Feature

Film media (taken at 24 frames per second) is faithfully reproduced on the projection display.



Press the MENU button to display the MENU screen.

1

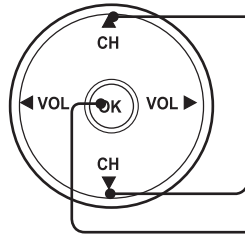

Press to select PICTURE.

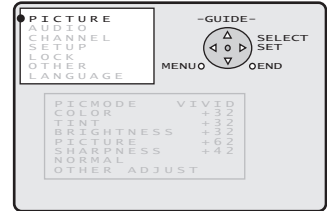

Press to display the PICTURE screen.

2

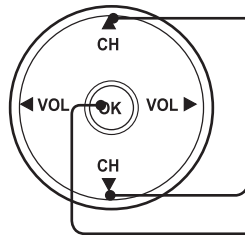

Press to select OTHER ADJUST.

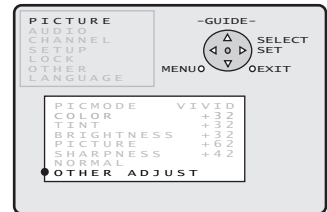

Press to display the OTHER ADJUST screen.

3

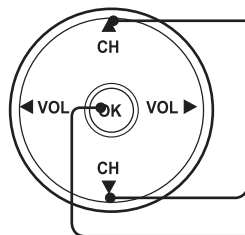

Press to select 3D I/P.

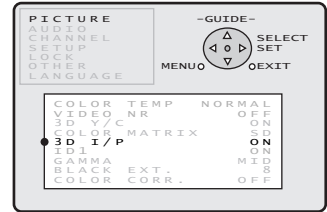

Press to set "ON" or "OFF".

ON: Recordings created at 24 frames per second are shown in higher quality.

OFF: Set to OFF if picture appears unnatural.

4



Press to exit menu.

GAMMA Adjust Feature

The median brightness level of the picture can be set.



Press the MENU button to display the MENU screen.

1

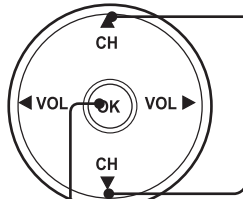

Press to select PICTURE.

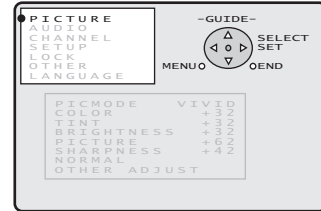

Press to display the PICTURE screen.

2

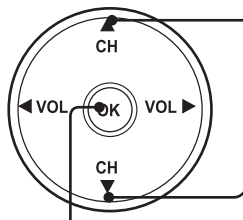

Press to select OTHER ADJUST.

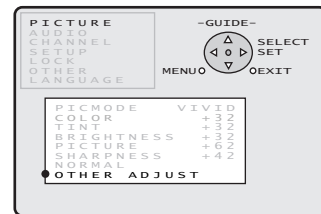

Press to display the OTHER ADJUST screen.

3

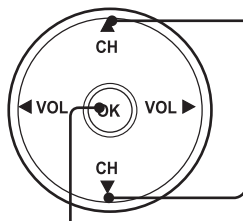

Press to select GAMMA.

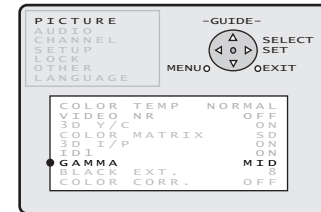

Press repeatedly to select the desired GAMMA.

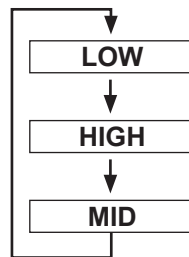

LOW : Median brightness is reduced.
 HIGH : Median brightness is increased.
 MID : Standard picture.

4



Press to exit menu.

Black Extension Feature

You can adjust the gray level of black for areas of the screen that are darker than the median level.



Press the MENU button to display the MENU screen.

1

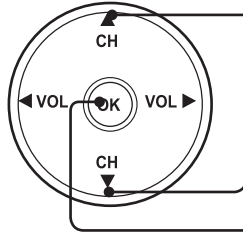

Press to select PICTURE.

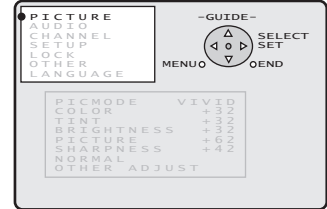

Press to display the PICTURE screen.

2

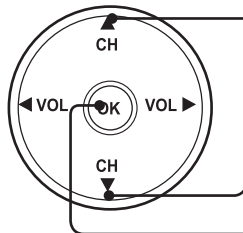

Press to select OTHER ADJUST.

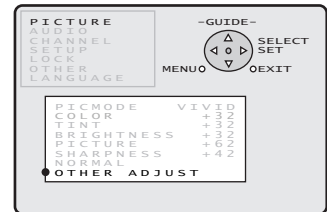

Press to display the OTHER ADJUST screen.

3

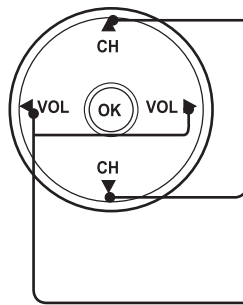

Press to select BLACK EXT..

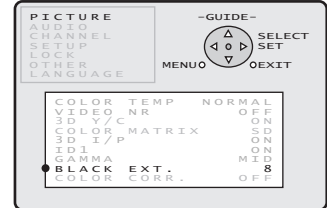

Adjust to desired level.

4



Press to exit menu.

Color Correct Feature

With HDMI connection, depending on the signal, the picture may be displayed with unnatural colors (as if red and blue are reversed). Correct by setting the **COLOR CORR.** to Invert.



Press the MENU button to display the MENU screen.

1

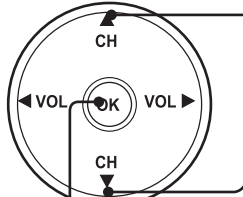

Press to select PICTURE.

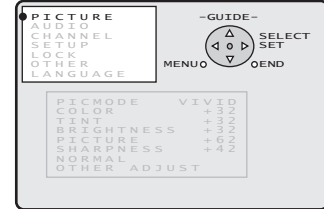

Press to display the PICTURE screen.

2

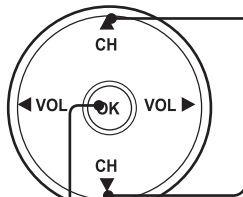

Press to select OTHER ADJUST.

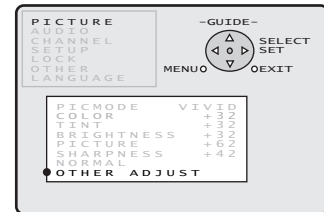

Press to display the OTHER ADJUST screen.

3

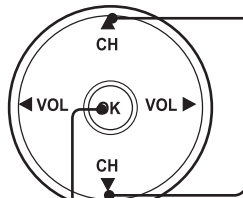

Press to select COLOR CORR..

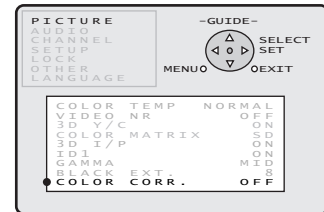

Press to set "ON" or "OFF".

ON: Set to ON if picture appears unnatural.
OFF: Usually set to OFF.

4



Press to exit menu.

Sleep Timer Feature

The projection display can be set to shut itself off at a preselected time.



Press the MENU button to display the MENU screen.

1

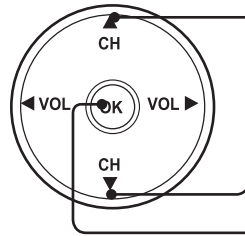

Press to select OTHER.

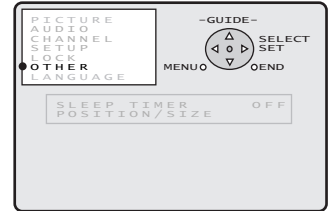

Press to display the OTHER screen.

2

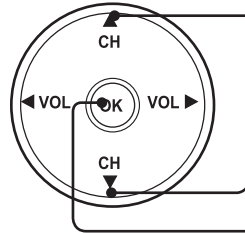

Press to select SLEEP TIMER.

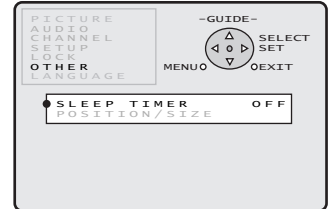

Press repeatedly to select the desired time.

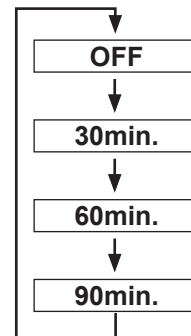

3



Press to exit menu.

Notes:

- Pressing RECALL with sleep timer set displays remaining time.
- Minutes remaining is displayed for the last 3 minutes before shutdown.

Switching languages for display

The language of the projection display is set to English as the factory setting. To select one of 3 different languages for on-screen displays, follow the instructions below.



Press the MENU button to display the MENU screen.

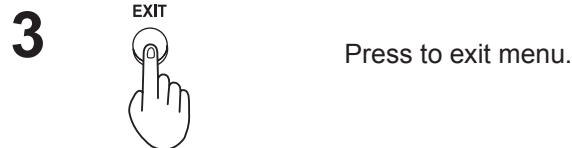
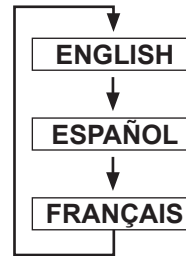
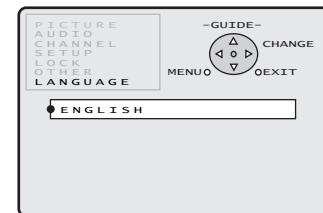
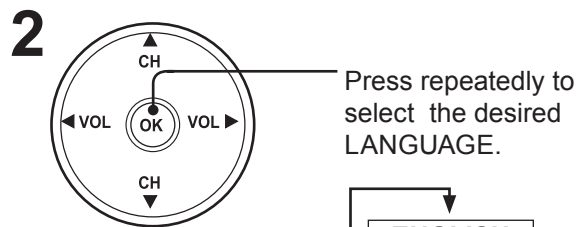
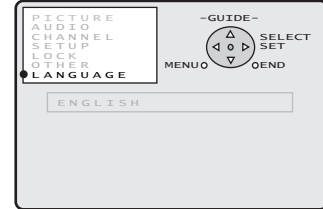
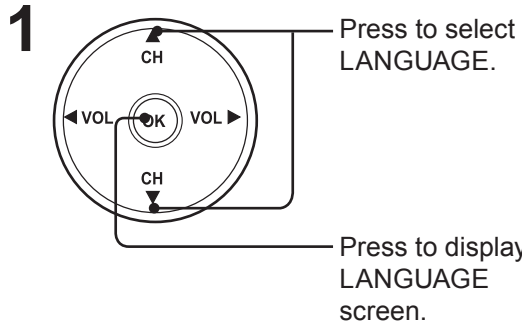

Photo Viewer (SD Card/PC Card)

Still image data (JPEG) made with a digital camera, digital video camera, or PC can be played back using an SD Card/PC Card.

WARNING

As with any small object, SD cards can be swallowed by young children. Do not allow children to handle the SD card.

Displayable Image Formats:

Baseline JPEG

(80 x 60 ~ 5 120 x 3 840 pixels)

Notes:

- Some parts of an image may not be displayed or the image may be displayed on a smaller scale depending on the size of the image.
- Only JPEG images can be displayed on this Projection display.
- Photo Viewer may not work with some Cards.

Card Data Protection

- Do not remove the card while it is being accessed.
- Do not touch the terminals on the back of the SD Card/PC Card.
- Electrical interference, electrostatic discharges and malfunctions of the unit or card may all result in damage to the card or data loss. It is recommended that any important data also be backed up on a PC.
- Stored data should be periodically backed up as a protection against data corruption, data loss or device malfunction. Please note that our company shall not accept any liability for damage or loss of stored data.

Caution

- Always insert card in the correct direction. Failure to do so may result in damage to the card and this unit.
- The SD Card and PC Card are precision devices. Do not subject them to excessive pressure or strong impacts.

Folders and Files

Digital cameras that are compliant with DCF specifications use folders with a specific structure. The following diagram shows an example of the folder structure.

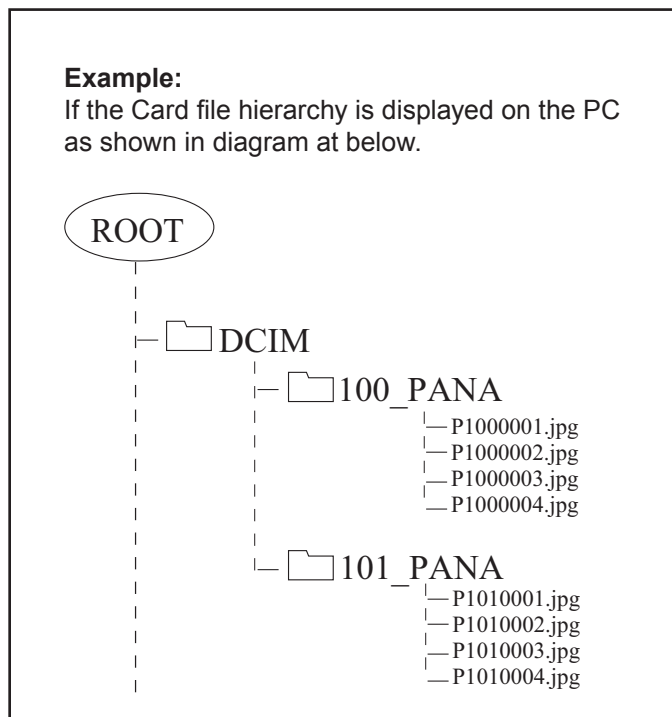

DCIM Folder

The digital camera creates this folder automatically.

100_PANA Folder

Folder names consist of a 3-digit folder number which is followed by five arbitrary characters. Digital camera images are stored within these folders.

JPEG files in the 100_PANA folder are displayed when a Card, which is structured as shown left, is inserted. To display another folder, see page 70 Index Area Operation.

Note:

- The folder and file name may vary according to the digital camera being used.

P1000001.JPG: DCF File

File names consist of four arbitrary characters followed by a 4-digit file number. DCF files are image files (normally JPEG files) that have been taken by a digital camera.

Photo Viewer (SD Card/PC Card)

Insert the Card.

Front Card Slot (P. 10)

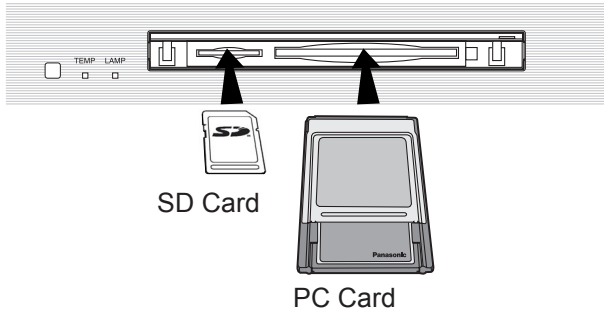

Remove the Card.

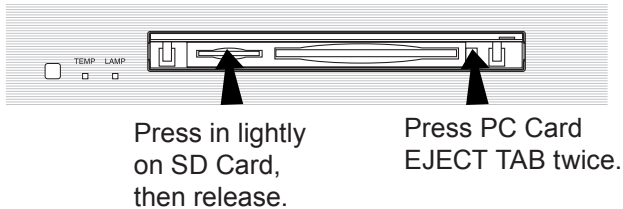

Compatible Card

SD Card slot	PC Card slot
SD Card	Compact Flash*
MultiMediaCard	Smart Media*
	Memory Stick*
	xD Picture Card*

- The media* listed in the right column above can be read via the PC Card in the PC Card adaptor.
- Hard disk PC Cards, Flash ATA Cards, and other recorded media cannot be used.
- Place the selected media onto the PC Card and then insert into the PC Card Slot.
- When both an SD Card and PC Card are inserted, the SD Card contents has priority and will be displayed.
- If the Card is unusable, "CARD FORMAT NOT SUPPORTED" is displayed on-screen. Remove the Card only when ACCESS is not displayed.
- If an incompatible JPEG file is displayed (full size file preview), "DATA FORMAT NOT SUPPORTED" is displayed.

Notes:

- Insert/remove Card while "Card Menu Screen" or "NO CARD" is displayed.
- Be sure ACCESS is not displayed before Card insertion/removal.
- Fully insert the Card (ACCESS is displayed). Wait until ACCESS goes out before removing.
- Before reinserting a Card after removing it, wait until "NO CARD" is displayed. If there are Cards in both Card Slots, wait until the Card Menu Screen of the other Slot is displayed and ACCESS is no longer displayed before reinserting a Card.

Card Menu Screen

The screen below is displayed automatically when a card is inserted. If "NO CARD" appears, confirm that a card is correctly inserted.

Parent Folder
Returns currently displayed folder to the parent (previous) folder.

Subfolder
The subfolder of the currently displayed folder is opened.

Display Page No.
When the displayed files/folders fill more than one page, the total number of pages is displayed.

Index Area
Folders and files are displayed here.

Notes:

- Up to 1 000 JPEG files can be displayed. (This number may be lower if subfolders, or files other than JPEG are included in the folder.)
- Depending on JPEG file type, "JPEG" will be displayed instead of thumbnail image.
- Only JPEG files can be displayed.

Menu Area
Select display method (SINGLE PLAY or SLIDE SHOW). Confirm the displayed card type (SD Card or PC Card).

ACCESS Indication
ACCESS is displayed while data is read.

Folder Name Area
The name of the selected subfolder (framed in yellow) is displayed.

Photo Viewer (SD Card/PC Card)

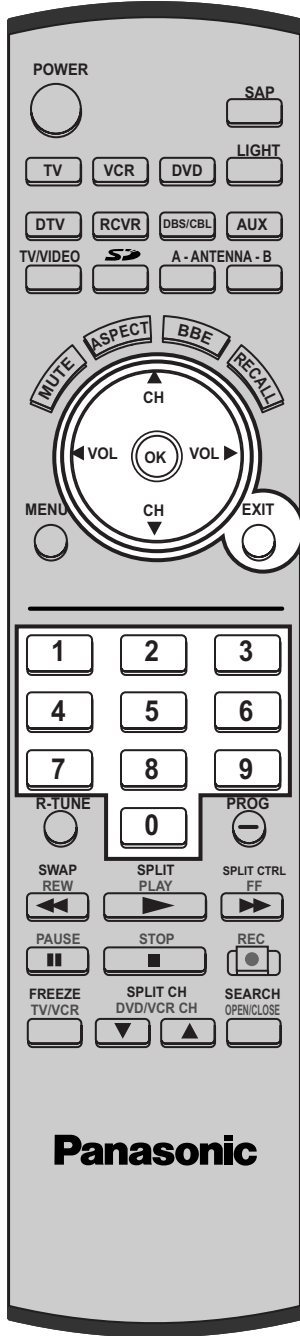

MENU Area Operation

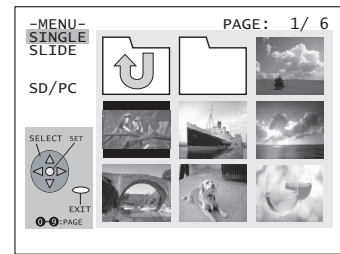
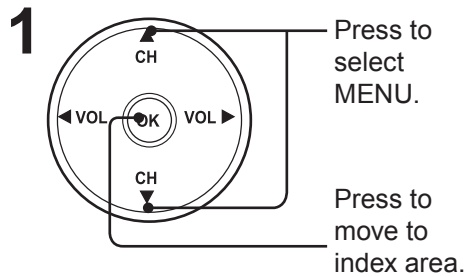

SINGLE

A single image selected from the index area fills the screen. You can also rotate the image and view image information. (PP. 71-72)

SLIDE

Images are displayed one after another as a slide show. Also, the SPEED and Transition features (p. 72) can be used.

SD/PC

When both an SD Card and PC Card are inserted, the ◀▶ buttons can be used to select a card in the index area.

Index Area Operation

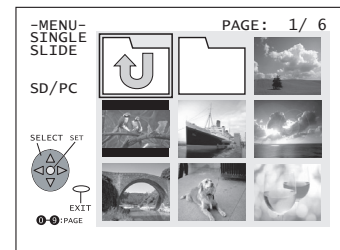
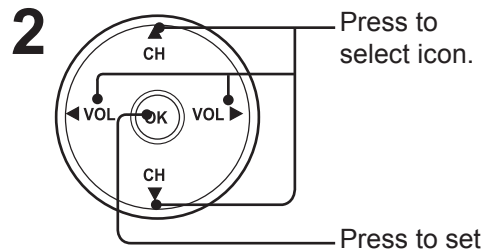

To select a page directly, enter the page number with the Number Keys, then press OK.

Select an Image file.

Display full size file preview.

Select a Subfolder (📁).

Display files/folders contained in the folder.

Select a Parent folder (👈).

Make changes to the parent (previous) directory display.

Note:

File and folder names will not be displayed correctly if...

- More than 8 characters are used.
- Spaces and special symbols are used. Use care when changing file and/or folder names.

RETURN Operation

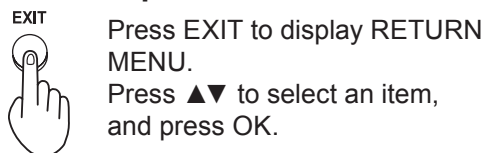

RETURN:

Returns to the parent (previous) folder.

RETURN TO MENU:

Returns to Menu Area screen.

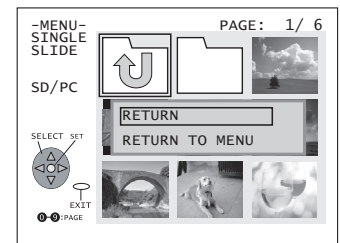
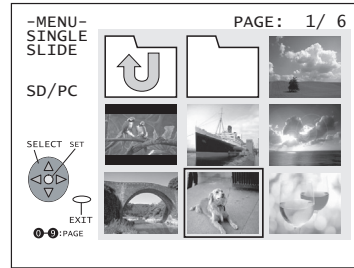

Photo Viewer (SD Card/PC Card)

Single Play Mode

- Press ▲▼ to select "SINGLE," and press OK.
Press ▲▼◀▶ to move cursor to desired file in INDEX AREA.
(Press ▲▼◀▶ to display next/previous page of 9 thumbnail files),
Press OK to display file in full screen size.



SINGLE VIEW SCREEN

Card Menu
screnn Area



Monitor
Screen Area

Example: Aspect 4:3 picture

Card Menu
screnn Area



Monitor
Screen Area

Example: Aspect 16:9 picture

- Press ▶ : The next image is displayed.
- Press ◀ : The previous image is displayed.
- Press ▼ : Each press rotates image 90°.

Note:

- When changing folders or images, the rotation setting is returned to the initial position.

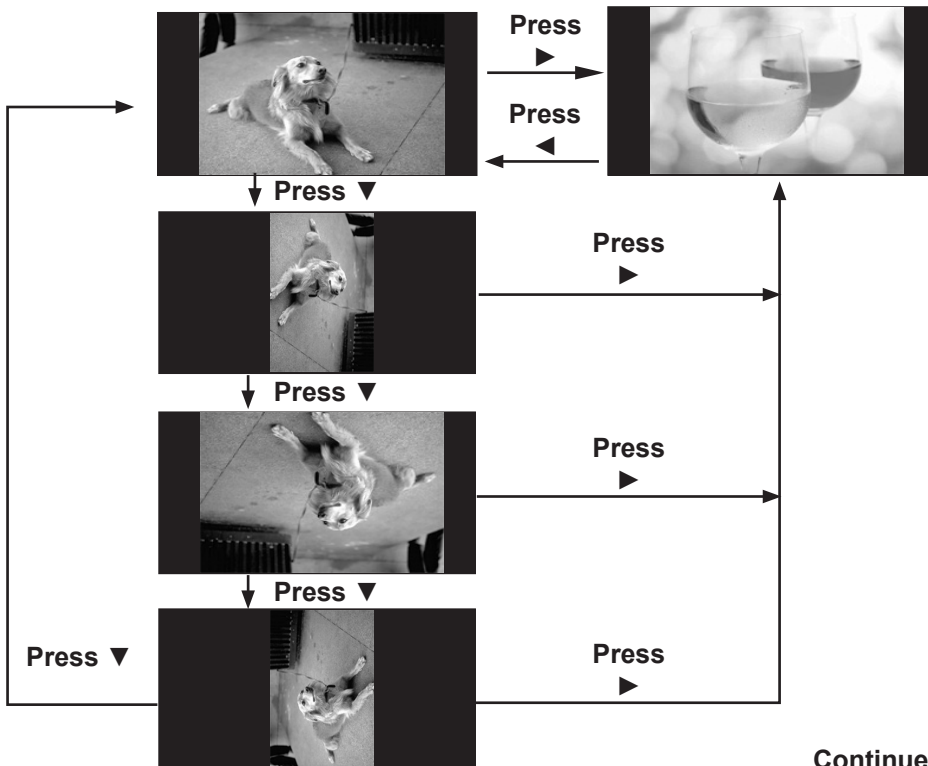

Continued in left column of next page.

Photo Viewer (SD Card/PC Card)

Continued from page 71.

ZOOM SETTING

A Single View Screen can be changed from Normal Screen Mode to Zoom Screen Mode by pressing ASPECT. The picture will fill the entire screen. To return to normal screen, press ASPECT again.

	NormalScreenMode	ZoomScreenMode
4:3 PICTURE		
16:9 PICTURE		

Information Screen Display

Press OK: INFORMATION SCREEN is displayed. (Rotation angle is maintained.)

Information Screen

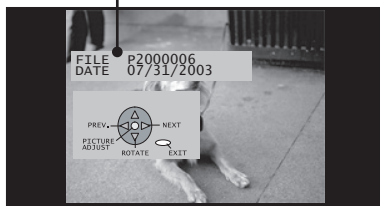

Pressing EXIT returns to SINGLE VIEW SCREEN.

Note:

- If a file name exceeds 8 characters, a file name different from the original is displayed.

Picture Adjustment

When OK is pressed while the Information Screen is displayed, the Picture Adjust menu (p. 44) is displayed. (Rotation angle is maintained.)

Picture Adjust menu



Pressing EXIT returns to SINGLE VIEW SCREEN.

- 2 Press EXIT with SINGLE VIEW screen displayed to return to the Index Area menu.

Slide Show Mode

- 1 Press ▲▼ to select "SLIDE," and press OK. Press ▲▼◀▶ to move cursor to desired file in Index Area. (Press ▲▼◀▶ to display next/previous page of 9 thumbnail files). Press OK to display SLIDE MENU. Press ▲▼ to select an item, and press OK repeatedly to set.

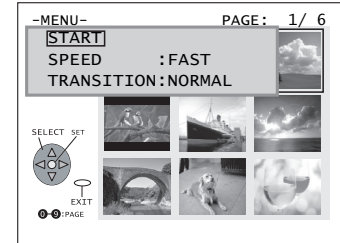

[START]
Starts slide show.

[SPEED]
FAST:
Image transition every 2 seconds.
MEDIUM:
Image transition every 5 seconds.
SLOW:
Image transition every 10 seconds.

Note:

- The display intervals of 2, 5, and 10 seconds do not include file data reading time. The display interval becomes longer depending on the JPEG size.

[Transition]
NORMAL:
Image transition one by one.
WIPE:
Image transition from top to bottom.
BLIND:
Image transition in a series of band-like shapes that resemble window blinds.

- 2 START SLIDE SHOW.



Press OK to stop or resume slide show.

- 3 Press EXIT to exit this mode.

Replacing the lamp unit

The lamp unit is sold separately. To purchase a replacement, call the Panasonic accessory department, toll free at: 1-800-332-5368.

Lamp unit Part No. : TY-LA1000

Lamp unit replacement period

The Lamp is a consumable item and its life varies based on individual usage. Panasonic warrants the original Lamp for a period of 1 year from the date of purchase.

- The unit will detect when the Lamp's end of life is approaching and the following message will be displayed.
- The LAMP indicator light will be lit when the Lamp's end of life is approaching.

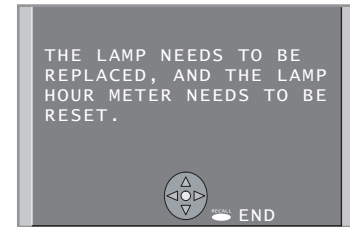

Influences of frequent lighting, continuous light use for over 24 hours, the number of times lit, the length of time between lightings, etc. may shorten lamp life.

(Because of this, we recommend having a replacement lamp on hand.)

WARNING

Failure to follow these warnings when replacing the lamp unit could result in personal injury:

- 1) The high-pressure lamp could explode if not properly handled and lamp fragments could cause injury.
- 2) Because the temperature of the lamp unit is elevated immediately after its use, touching it may cause burns. Please allow the lamp to cool before handling or replacing the lamp unit.
- 3) Handle the old lamp unit carefully. It can explode if not handled with care.
- 4) Wear gloves and safety eyeglasses when replacing the lamp unit.
- 5) If replacement of the lamp unit becomes necessary during the operation of the TV, follow the procedure below.
 - a. Press the POWER button on the remote control unit to turn off the power.
 - b. Wait for about 1 minute until the cooling fan stops.
 - **The lamp cooling fan will continue to operate for about 1 minute after turning off the power. Do not unplug the power cord from the outlet until the fan has stopped. Avoid interrupting the power line by using circuit breakers or switchable power strips.**
 - c. After the cooling fan has stopped, Unplug the power cord from the outlet.

- Please wait more than one hour for lamp replacement.
[If you need to replace the lamp more urgently]
- The projection display has a forced cooling feature. After the POWER button is turned OFF, and sometime during about the first minute of the normal cooling fan operation, press the VOL+ button on the projection display and the ▲ button on the Remote control at same time for more than 5 seconds. The cooling fan operates for about 10 minutes.

Refer to the instructions enclosed with the lamp unit (Part No.: TY-LA1000) when replacing the lamp.

Warning Indicators

This unit has indicators (lights on the front) to let you know the unit's internal condition. (See page 10)
Depending on the condition, the Lamp, Power, or Temp indicator will flash to alert you. In this case, turn unit off and follow the measures below.

	Indicator	Symptom	Problem	Possible Solution
Temp Indicator	Flashes red 1 or 3 times every 5 seconds.	Power shuts off.	Malfunction	Contact a service center.
	Flashes red 2 or 4 times every 5 seconds.	Power shuts off.	Internal overheat error.	Wait a while, then turn unit back on.
	Flashes red 5 times every 5 seconds.	Power shuts off.	Malfunction	Contact a service center.
Lamp Indicator	Lights solid red.	OSD appears every time power is turned on.	Maximum Lamp life hours exceeded.	Replace Lamp
	Flashes red 1 time ever 5 seconds.	Power shuts off.	Lamp will not light or light is abnormal.	Try turning Power On several times. If error persists, contact service center.
	Flashes red 2 times every 5 seconds.	Power shuts off.	Lamp voltage is abnormal.	Contact service center.
	Flashes red 3 times every 5 seconds.	Power shuts off.	Lamp temperature is too high.	Contact service center.
	Flashes red 4 times every 5 seconds.	Power shuts off.	Other error.	Contact service center.
Power Indicator	Flashes orange 1 time every 5 seconds.	Power shuts off.	The internal cooling fan is not working.	Contact service center.
	Flashes orange 2 times every 5 seconds.	Power shuts off.	The Lamp Cover is unsecured.	Securely attach Lamp Cover.

Note:

- If unit power is turned back on after performing the appropriate measures, make sure the unit has sufficiently cooled down. If the unit was used for a long period such that the lamp needs enough time to cool down, this may take a while.

Remote Control Quick Reference Guide (Operating peripheral equipment)

Programming The Remote

The Universal Remote Control can be programmed to operate many manufacturers' components, using the component function buttons for VCR, DVD, DTV, RCVR, DBS, CBL or AUX. Follow the procedures for programming your Remote Control with or without a code for the component.

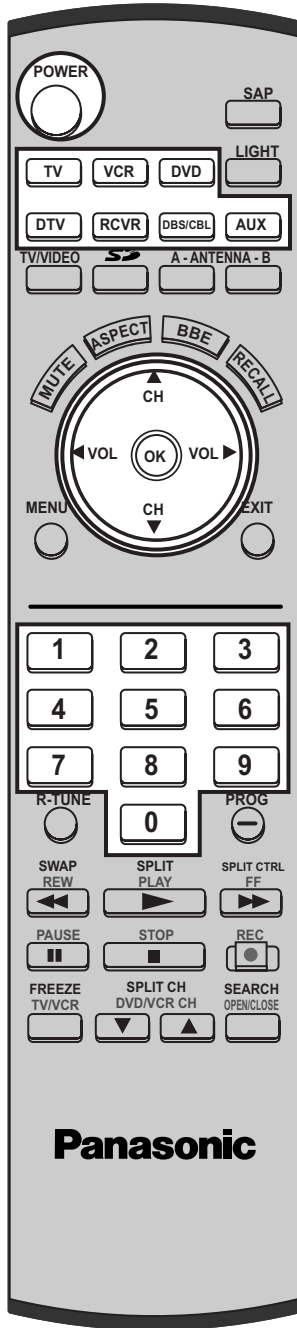

Setting up the remote using the Number keys.

(When code is known):

1



Confirm that the external component is plugged and operating. Turn the component off.

Press OK and POWER together, for at least 5 seconds.

+

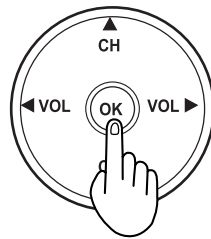

2



Press appropriate component button on the Remote Control VCR, DVD, DTV, RCVR, DBS/CBL or AUX (PVR or VCR2)

3

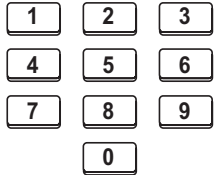

Enter the 3-digit component code using the Remote Control number keys (0 ~ 9 buttons). Press the Remote Control POWER to test the component. If the procedure was successful, the component will turn on.

Device	Operates	Default
TV	TV (Panasonic Only)	Panasonic Code
VCR	VCR (Preset)	Panasonic Code
DVD/CD	DVD and CD (Preset)	Panasonic Code
DBS/CBL	DBS STB & CBL STB (Preset) and Cable (Preset)	Panasonic DBS Code and Panasonic CABLE Code
RCVR	Audio Receiver (Preset)	Panasonic RCVR Code
AUX	Personal Video Recorders, Cassette and VCR2	Panasonic Personal Video Recorder Code
DTV	DTV (Panasonic Only)	Panasonic Only

Notes:

- Determine the manufacturer of the component and look in the table for the code.
- If the component does not operate with the Remote Control, repeat the procedure using another code. (Some brands have multiple codes). If an incorrect code is entered, or if the procedure takes longer than 30 seconds, the programming will fail.

Remote Control Quick Reference Guide (Operating peripheral equipment)

Programming Without A Code

This procedure searches all codes and is called the “sequence method.”



Setting to the remote using the step and set method
(When code is not known):

1



Confirm that the external component is plugged in and on. Turn the component off.

Press OK and POWER together, for at least 5 seconds.

+

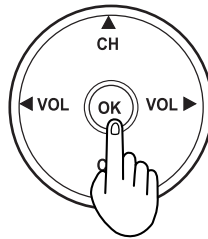

2



Press appropriate component button on the Remote Control.

3

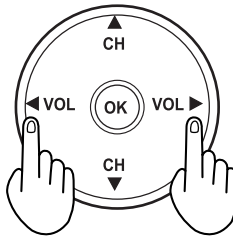

Press VOL ► to move forward to the next code. Press VOL ◀ to move backward.

Press the Remote Control POWER to test the component. If the procedure was successful, the component will turn on.

Note:

- Repeat the above steps until the component code is found. It may take many attempts before the correct code is found.

After the code is found, press **OK** to store the code.

4

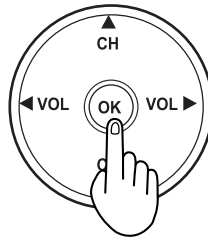

Component Codes

The Universal Remote Control is capable of operating many component brands after entering a code. Some components may not operate because the codes are not available due to limited memory. The Universal Remote Control does not control all features found in each model.

Write the code numbers from tables in this space. This will serve as a reference if you need to program your Remote Control.

CABLE

Cable Box

DBS

Digital Broadcast System

Other Component

VCR

Video Cassette Recorder

RCVR

Receiver or Amplifier

Other Component

CD

Compact Disc Player

DVD

Digital Versatile Player

Other Component

Remote Control Quick Reference Guide (Operating peripheral equipment)

Infrared Codes Index

The Remote Control is capable of operating many brands of peripheral equipment. Refer to page 75 and 76 for programming procedures.

Notes:

- The Remote Control memory is limited and therefore some models may not operate. The Remote Control is not designed to control all features available in all models.
- After entering the proper infrared code, press the desired Mode Selection button on the Remote Control. Refer to page 8 to 9 and 80 to 81 for details on operating peripheral equipment using the Remote Control.

VCR Infrared Codes Index

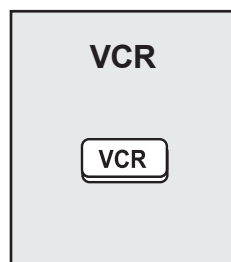

Codes For VCR		Codes For VCR (Contd.)	
Brand	Code	Brand	Code
Admiral	335	Optimus	306, 321, 328, 335
Aiwa	332	Orion	320, 326
Akai	314, 315, 316, 329	Panasonic	321, 322, 323, 324
Audio Dynamic	311, 339	Penney	300, 305, 310, 311, 324, 339, 345
Bell & Howell	305, 313	Pentax	300, 311, 345
Broksonic	320, 326	Philco	320, 323, 324, 326, 331, 343
Canon	323, 325	Philips	323, 324, 331
CCE	343	Pioneer	323
Citizen	306	Proscan	300, 301, 302, 323, 324, 331, 333, 345, 346
Craig	305, 306, 329	Quasar	321, 322, 323, 324
Curtis Mathes	324, 345	Radio Shack	305, 309, 324, 333, 336, 340
Daewoo	301, 324, 343	RCA	300, 301, 302, 323, 324, 331, 333, 345, 346
DBX	310, 311, 339	Realistic	305, 309, 324, 336, 340
Dimensia	345	Samsung	302, 304, 333
Emerson	303, 319, 320, 325, 326, 343	Sansui	320, 326, 339, 352
Fisher	305, 307, 308, 309, 313	Sanyo	305, 309, 313
Funai	320, 326, 334	Scott	301, 302, 304, 309, 320, 326, 338, 340, 347, 348
GE	324, 333, 345	Sears	300, 305, 306, 307, 308
Goldstar	306	Sharp	335, 336
Gradiente	334	Shintom	317
Hitachi	300, 323, 345	Signature 2000	335
Instant Replay	323, 324	Singer	337
Jensen	339	Sony	328, 329, 330
JVC	310, 311, 334, 339	Sylvania	323, 324, 331
Kenwood	306, 310, 311, 339	Tashiro	306
LXI	300, 305, 306, 307, 308, 309	Tatung	310, 311, 339
Magnavox	323, 324, 331	Teac	310, 311, 339
Marantz	310, 311, 339	Technics	321, 322, 323, 324
Marta	306	Teknika	324
Memorex	309, 324	Toshiba	301, 346
MGA	338, 340, 341, 347, 348	Vector Research	311
Minolta	300, 345	Wards	306, 309, 335, 336, 344
Mitsubishi	338, 340, 341, 347, 348	Yamaha	305, 310, 311, 339
Multitech	304, 347	Zenith	306, 344
NEC	310, 311, 334, 339		
Olympic	323, 324		

Remote Control Quick Reference Guide (Operating peripheral equipment)

CABLE CONVERTER BOX AND DVD, CD PLAYERS Infrared Codes Index

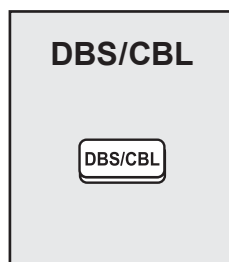

Codes For DBS	
Brand	Code
Dish Network (EchoStar)	105, 115, 116
EchoStar	105
Express VU	105, 115
G. E.	106
G.I. (General Instrument)	108
Gradiente	114
Hitachi	103, 111, 112
HNS (Hughes)	103

Codes For DBS (Contd.)	
Brand	Code
Magnavox	101, 102
Panasonic	104
Philips	101, 102
Primestar	108
Proscan	106, 109, 110, 113
RCA	106, 109, 110, 113
Sony	107
Star Choice	103, 108
Toshiba	100
Uniden	101, 102

Codes For Cable Box	
Brand	Code
ABC	124
Archer	125, 132
Cableview	105, 132
Citizen	105, 122
Curtis	112, 113
Diamond	124, 125, 132
Eagle	129
Eastern	134
GCbrand	105, 132
Gemini	122
General Instrument/Jerrold	111, 119, 120, 121, 122, 124, 125, 126, 127
Hamlin	112, 118, 140, 141, 142, 145
Hitachi	103, 124
Macom	103, 104, 105
Magnavox	133
Memorex	130
Movietime	105, 132
Oak	102, 137, 139
Panasonic	109, 110, 114
Philips	106, 107, 128, 129, 130
Pioneer	101, 116
Pulsar	105, 132

Codes For Cable Box (Contd.)	
Brand	Code
Puser	132
RCA	115
Realistic	132
Regal	112, 118, 140, 141, 142, 145, 149
Regency	134
Rembrandt	105, 132, 137
Samsung	105
Scientific Atlanta	111, 112, 113
Slmark	101, 105
Sprucer	105, 110
Stargate	105, 110
Televue	101, 105
Texscan	144
Tocom	135
Toshiba	104
Unika	125, 232
Universal	122, 132
Videoway	106
Viewstar	129, 130
Zenith	100, 117
Zenith/Drake Satellite	100

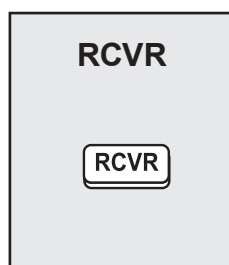

Codes For Receivers	
Brand	Code
Admiral	120
Aiwa	125, 126
Denon	134, 135, 136
Fisher	104
Garrard	113
Harman Kardon	115, 123
Jensen	129
JVC	132, 133
Kenwood	100, 108
Magnavox	127
Marantz	124
McIntosh	116
Nakamichi	106
Onkyo	109, 114

Codes For Receivers (Contd.)	
Brand	Code
Optimus	103, 127, 130, 131
Panasonic	118, 119, 121
Philips	123
Pioneer	105, 107
Quasar	118, 119, 121
RCA	103, 105, 127, 130, 131
Sansui	103, 111, 139
Sharp	134, 137
Sony	122
Soundesign	138
Teac	111, 112, 113
Technics	118, 119, 121
Victor	132, 133
Yamaha	101, 102

Remote Control Quick Reference Guide (Operating peripheral equipment)

CASSETTE PLAYERS, PERSONAL VIDEO RECORDERS, RECEIVERS, AMPLIFIERS, and DBS Infrared Codes Index

AUX

AUX

Codes For Cassette Decks	
Brand	Code
Aiwa	223, 224, 225
Denon	231
Fisher	203
Jensen	214
JVC	229, 230
Kenwood	200, 207
Marantz	202
Nakamichi	205
Onkyo	208, 209, 213
Panasonic	216, 218

Codes For Cassette Decks (Contd.)	
Brand	Code
Philips	222
Pioneer	204
RCA	226, 227, 228
Sansui	205, 210
Sharp	231
Sony	219, 220
Teac	210, 211, 215
Technics	216, 218
Yamaha	201, 202

Codes For Personal Video Recorders	
Brand	Code
Panasonic Replay TV	100
Philips Tivo	102
Sony Tivo	101

DVD

DVD

Codes For DVD	
Brand	Code
Denon	100
Ferguson	101
JVC	109
Mitsubishi	105
Nordmende	101
Panasonic	100
Philips	103
Pioneer	102
RCA	101

Codes For DVD (Contd.)	
Brand	Code
Saba	101
Samsung	110
Sharp	108
Sony	104
Technics	100
Thomson	101
Toshiba	103
Yamaha	100
Zenith	107

Codes For CD Player	
Brand	Code
Admiral	226
Aiwa	233, 235
Carver	229
Denon	242
Emerson	239
Fisher	205
Harman/ Kardon	219, 220, 221, 223
Hitachi	207
Jensen	234
JVC	240, 241, 245
Kardon	223
Kenwood	200, 201, 211, 245
LXI/Sears	236
Magnavox	229, 232
Marantz	229
McIntosh	221
Nakamichi	210
Onkyo	214, 215

Codes For CD Player (Contd.)	
Brand	Code
Optimus	208, 218, 220, 222
Panasonic	224, 225, 227
Philips	229, 230
Pioneer	208
Quasar	224, 225, 227
RCA	231, 237, 238, 247
Sansui	210, 246
Sanyo	205
Scott	210, 246
Sharp	242, 243
Sherwood	220
Sony	228
Soundesign	244
Teac	212, 216, 218
Technics	224, 225, 227
Victor	240, 241, 245
Yamaha	202, 203, 204

Remote Control Quick Reference Guide (Operating peripheral equipment)

Operating Components with Remote Control

Note:

- Refer to pages 8-9 for programming Remote Control procedure.

Operating a VCR

Program the Remote Control to use with VCR.

TO DO THIS...	PRESS
Turn on/off	
Select TV Input mode for VCR	
Change Channels up/down	
Record	
Play	
Stop	
Fast Forward	
Rewind the Tape	
Pause	
Change to TV or VCR Mode	
On screen VCR Display	

Operating a DBS

Program the Remote Control to use with DBS.

TO DO THIS...	PRESS
Turn on/off	
Display DBS menu	
Menu Navigation	
Select a Channel	
Program Information	
Back to previous channel	
Select next page up/down	
Exit menus	

Operating a CABLE BOX

Program the Remote Control to use with Cable Box.

TO DO THIS...	PRESS
Turn on/off	
Select a Channel	
Change Channels Up/Down	
Back to previous channel	

Operating a DVD

Program the Remote Control to use with DVD.

TO DO THIS...	PRESS
Turn on/off	
Next/Previous Chapter	
DVD Display	
Skip Search Reverse	
Skip Search Fast Forward	
Play	
DVD Open/Close	
Stop	
Still	
Slow +/-	

Remote Control Quick Reference Guide (Operating peripheral equipment)

Operating Components with Remote Control

Operating a Cassette Deck

To operate a cassette deck, the Remote Control must be in AUX mode and be programmed with the appropriate code for your equipment.

TO DO THIS...	PRESS
Turn on/off	POWER
Receiver Volume Up/Down	
Deck A/B	R-TUNE
Record	REC
Play	SPLIT PLAY
Stop	STOP
Fast Forward	SPLIT CTRL FF
Rewind the Tape	SWAP REW
Pause	PAUSE

Operating a Receiver

Program the Remote Control to operate audio receiver.

TO DO THIS...	PRESS
Turn on/off	POWER
Audio Mute	MUTE
RCVR. VOI Up Down	
Tuner Pre-set stations Up/Down	
To select AV Inputs or Components:	Press Remote Control Number keys AV1: Press 1 AV2: Press 2 AV3: Press 3 AV4: Press 4 CD: Press 5 TUNER: Press 6 PHONO: Press 7 TAPE: Press 8 AUX: Press 9

Operating a Receiver

Program the remote to operate audio receiver.

TO DO THIS...	PRESS
Surround VOL Down	SWAP REW
Surround VOL UP	SPLIT CTRL FF
Center CH VOL Up/Down	SPLIT CH DVD/VCR CH

Operating a PVR (Personal Video Recorder)

Program the Remote Control to use with a PVR.

TO DO THIS...	PRESS
Turn on/off	POWER
Display PVR menu	MENU
PVR Navigation	
Select a Channel	1 2 3 4 5 6 7 8 9 0
Play	SPLIT PLAY
Record	REC
Pause	PAUSE
Back to previous channel	R-TUNE
Exit menus	EXIT
Replay Zones	R-TUNE
Quick Skip	SEARCH OPEN/CLOSE
Return to live	PROG
PVR CH Up/Down	SPLIT CH DVD/VCR CH

Notes:

- Not all functions listed may be controllable.
- Some TV, Cable Box and DSS Receiver brands require you to turn on the power manually.

Troubleshooting

Before you call for service, determine the symptoms and make a few simple checks as shown below.

Symptoms	Checks	Page
Power does not turn ON.	<ul style="list-style-type: none"> Is the power plug plugged in? 	22
No picture even if the power is turned ON. LAMP indicator blinks red.	<ul style="list-style-type: none"> Please replace lamp with a new one. Please consult your nearest dealer, if not still repaired. 	73-74
The power turns OFF.	The POWER indicator flashes orange twice every 5 seconds. <ul style="list-style-type: none"> The lamp cover is ajar. Firmly replace the cover. 	74
	The TEMP indicator flashes 2 or 4 times every 5 seconds. <ul style="list-style-type: none"> Check whether or not the vents are clogged. Is the set being used in a location that is hot? 	74
	The TEMP indicator flashes 5 times every 5 seconds. <ul style="list-style-type: none"> Please consult your nearest dealer. 	74
	Power turns off while another indicator is flashing. <ul style="list-style-type: none"> Please consult your nearest dealer. 	74
Remote control does not function.	<ul style="list-style-type: none"> Are the batteries dead or inserted incorrectly? 	7
	<ul style="list-style-type: none"> Is the remote control sensor in direct light of fluorescent lamps or other strong sources of light? 	-
	<ul style="list-style-type: none"> Did you correctly set the remote control code? 	75
Image shakes.	<ul style="list-style-type: none"> Is the antenna or antenna cable old, broken or shorted? 	-
Image is not clear.	<ul style="list-style-type: none"> Is the antenna cable connected properly? 	12-14
	<ul style="list-style-type: none"> Sudden changes in ambient temperature may cause condensation in the internal optics. Condensation should disappear after Power has been ON for a while. 	-
Color patches or no color.	<ul style="list-style-type: none"> When using a VCR and selecting channels on the TV, is the TV/VIDEO mode for the VCR set to TV? Is the antenna facing the right direction? 	-
Image appears doubled or tripled.	<ul style="list-style-type: none"> Is the antenna receiving any signals reflected off of mountains or buildings. 	-
Images disappear at the top and bottom of the screen.	<ul style="list-style-type: none"> When using 16:9 image software, there is no picture at the top and bottom of the screen (cinema vision size software, etc.). 	-
During ZOOM modes, the image is cut off at the top and bottom.	<ul style="list-style-type: none"> Has the screen position been changed? If so, adjust screen positioning. 	32-33, 40-41
Some parts of the screen are always lit while others do not light up. Some parts of the screen do not light up.	<ul style="list-style-type: none"> This is a characteristic of the LCD panel and not a malfunction. 	-
Fan is operating even though TV Power is OFF.	<ul style="list-style-type: none"> This is because the cooling fan is operating. The fan will stop after about 1 minute. 	22
An OSD instructing to replace the lamp is displayed. (The LAMP indicator is lit red.)	<ul style="list-style-type: none"> Replace lamp with a new one. 	73-74
Relighting the lamp when it is hot makes a sound.	<ul style="list-style-type: none"> This is a characteristic of the lamp and not a malfunction. 	-
Leaving stationary images, such as still video images, web pages, or filler bars (used for NORMAL aspect mode), on-screen for an extended period of time can leave ghost images on the screen.	<ul style="list-style-type: none"> This is a characteristic of the LCD panel and not a malfunction. Try displaying constantly moving pictures which fill the entire screen, or turn the power OFF for a while to return the screen to normal. 	-
An OSD advising "AIR FILTER CLEANING..." is displayed.	<ul style="list-style-type: none"> Please consult your nearest dealer. 	-
When a bright picture is displayed, stain-like blotches appear.	<ul style="list-style-type: none"> This can occur if the ambient temperature changes suddenly. Try gently rubbing the stained areas with a soft cloth. 	-

Specifications



		PT-43LC14	PT-50LC14	PT-60LC14
Power Source		AC 120 V, 60 Hz		
Power Consumption		Power ON: Approx. 220 W (When audio is at maximum) Power OFF: Approx. 0.4 W (When cooling fan is stopped)		
LCD panels		0.7" Poly silicon TFT LCD panel x 3 921 600 (1 280 x 720) stripe pixels x 3 panels (16:9)		0.9" Poly silicon TFT LCD panel x 3 921 600 (1 280 x 720) stripe pixels x 3 panels (16:9)
Display		43-inch, 16 : 9 aspect ratio	50-inch, 16 : 9 aspect ratio	60-inch, 16 : 9 aspect ratio
Speaker		2 Speakers 30 W [15 W + 15 W] (10 % THD)		
HID Lamp		100 W HID (High Intensity Discharge) Lamp		
Channel Capability		VHF-12 : UHF-56 : Cable-125		
Input Terminals	RGB INPUT (PT-43LC14) RGB INPUT 1-2 (PT-50LC14/PT-50LC14)	RGB analog 0.7 Vp-p (75 Ω) (D-SUB15P) AUDIO 0.5 Vrms (M3 Stereo mini Pin Jack)		
	AV INPUT 1-3	VIDEO 1.0 Vp-p (75 Ω) (RCA Pin Jack) S-VIDEO Y : 1 Vp-p (75 Ω), C : 0.286 Vp-p (75 Ω) (Mini DIN 4 pin) AUDIO L-R 0.5 Vrms (RCA Pin Jack x 2)		
	COMPONENT VIDEO INPUT 1-4	Y 1.0 Vp-p (with sync) (75 Ω) (Pin Jack) P _B / P _R ± 0.35 Vp-p (75 Ω) (Pin Jack x 2) AUDIO L-R 0.5 Vrms (RCA Pin Jack x 2)		
	HDMI	HDMI type A Connector AUDIO L-R 0.5 Vrms (RCA Pin Jack Type × 2)		
Card slot	SD Card slot	SD Card, MultiMediaCard		
	PC Card slot	Compact Flash, Smart Media, Memory Stick, xD Picture Card		
Output signals (AV OUT)		VIDEO 1.0 Vp-p (75 Ω) (RCA Pin Jack) AUDIO L-R 0.5 Vrms (RCA Pin Jack x 2)		
Dimensions (W x H x D)		1 259 mm (W) x 795 mm (H) x 324 mm (D) 49-9/16" (W) x 31-5/16" (H) x 12-6/8" (D)	1 416 mm (W) x 897 mm (H) x 389 mm (D) 55-6/8" (W) x 35-5/16" (H) x 15-5/16" (D)	1 637 mm (W) x 1 050 mm (H) x 459 mm (D) 64-7/16" (W) x 41-3/8" (H) x 18-1/16" (D)
Weight (Mass)		31.3 kg (69 lbs.) Net	37.6 kg (82.9 lbs.) Net	46 kg (101.4 lbs.) Net
Operating conditions		Temperature : 0 °C – 35 °C (34 °F - 95 °F) Humidity : 20 % - 80 % (non-condensing)		

Note:

- Design and Specifications are subject to change without notice. Weight and Dimensions shown are approximate.

Cleaning

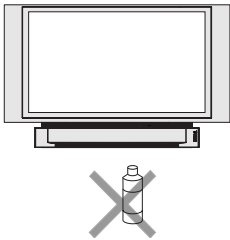
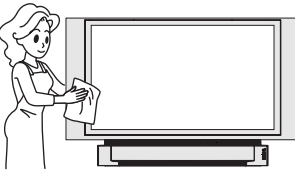
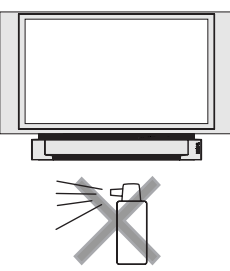
To ensure continued excellent performance by this product, periodic cleaning is recommended.

	<p>The unit contains many plastic parts. For this reason DO NOT use benzene, thinner or other chemicals to clean the unit.</p>		<p>Dust will accumulate on the picture screen. Please wipe with a soft cloth from time to time. If you use a chemically treated cloth, please be careful to follow the instructions that come with the cloth.</p>
	<p>DO NOT bring into contact with insecticide or other volatile substances. DO NOT allow the unit to come into contact for extended periods with rubber or vinyl products.</p>		<p>Remove dirt and soiling by wiping with a light cloth. Even if the unit is heavily soiled, do not apply cleaner directly to the unit. Soak a cloth in a solution of neutral cleanser diluted with water. Then wring out the cloth, wipe the unit clean, and finish by wiping with a dry cloth. Do not use any type of cleansers on the picture screen.</p>

Customer Services Directory

Obtain Product Information and Operating Assistance; locate your nearest Dealer or Servicer; purchase Parts and Accessories; or make Customer Service and Literature requests by visiting our Web Site at:

<http://www.panasonic.com/support>

or, contact us via the web at:

<http://www.panasonic.com/contactinfo>

You may also contact us directly at:

1-800-211-PANA (7262),

Monday-Friday 9 am-9 pm; Saturday-Sunday 10 am-7 pm, EST.

For hearing or speech impaired TTY users, TTY : 1-877-833-8855

Accessory Purchases

Purchase Parts, Accessories and Instruction Books online for all Panasonic Products by visiting our Web Site at:

<http://www.pasc.panasonic.com>

or, send your request by E-mail to:

npcparts@panasonic.com

You may also contact us directly at:

1-800-332-5368 (Phone) 1-800-237-9080 (Fax Only) (Monday – Friday 9 am to 8 pm, EST.)

Panasonic Services Company

20421 84th Avenue South,

Kent, WA 98032

(We Accept Visa, MasterCard, Discover Card, American Express, and Personal Checks)

For hearing or speech impaired TTY users, TTY : 1-866-605-1277

Service in Puerto Rico

Matsushita Electric of Puerto Rico, Inc. Panasonic Sales Company

Factory Servicer:

Ave. 65 de Infantería, Km. 9.5, San Gabriel Industrial Park, Carolina, Puerto Rico 00985

Phone (787)750-4300 Fax (787)768-2910

As of October 2003

Limited Warranty

PANASONIC CONSUMER
ELECTRONICS COMPANY, DIVISION
OF MATSUSHITA ELECTRIC
CORPORATION OF AMERICA
One Panasonic Way
Secaucus, New Jersey 07094

PANASONIC SALES COMPANY,
DIVISION OF MATSUSHITA
ELECTRIC OF PUERTO RICO, INC.,
Ave. 65 de Infantería, Km. 9.5
San Gabriel Industrial Park, Carolina,
Puerto Rico 00985

Panasonic Multimedia Projection Display Limited Warranty

Limited Warranty Coverage

If your product does not work properly because of a defect in materials or workmanship, Panasonic Consumer Electronics Company or Panasonic Sales Company (collectively referred to as “the warrantor”) will, for the length of the period indicated on the chart below, which starts with the date of original purchase (“warranty period”), at its option either (a) repair your product with new or refurbished parts, or (b) replace it with a new or a refurbished product. The decision to repair or replace will be made by the warrantor.

CATEGORY	PARTS	LABOR	SERVICE
Multimedia Projection Display	One (1) Year	One (1) Year	In-Home or Carry-In

During the “Labor” warranty period there will be no charge for labor. During the “Parts” warranty period, there will be no charge for parts. You must carry-in your product or arrange for in-home service during the warranty period. If non-rechargeable batteries are included, they are not warranted. This warranty only applies to products purchased and serviced in the United States or Puerto Rico. This warranty is extended only to the original purchaser of a new product which was not sold “as is”. A purchase receipt or other proof of the original purchase date is required for warranty service.

Carry-in or In-Home Service

For In-Home or Carry-In Service in the United States call 1-888-VIEW-PTV (1-888-843-9788).

For assistance in Puerto Rico call Panasonic Sales Company (787)-750-4300 or fax (787)-768-2910.

In-Home service requires clear, complete and easy access to the product by the authorized servicer and does not include removal or re-installation of an installed product. It is possible that certain in-home repairs will not be completed in-home, but will require that the product, or parts of the product, be removed for shop diagnosis and/or repair and then returned.

Limited Warranty Limits And Exclusions

This warranty ONLY COVERS failures due to defects in materials or workmanship, and DOES NOT COVER normal wear and tear or cosmetic damage. The warranty also does not cover damages which occurred in shipment, or failures which are caused by products not supplied by the warrantor, or failures which result from accidents, misuse, abuse, neglect, mishandling, misapplication, alteration, faulty installation, set-up adjustments, misadjustment of consumer controls, power line surge, lightning damage, modification, or commercial use (such as in a hotel, office, restaurant, or other business), rental use of the product, service by anyone other than a Factory Servicenter or other Authorized Servicer, or damage that is attributable to acts of God.

THERE ARE NO EXPRESS WARRANTIES EXCEPT AS LISTED UNDER “LIMITED WARRANTY COVERAGE”. THE WARRANTOR IS NOT LIABLE FOR INCIDENTAL OR CONSEQUENTIAL DAMAGES RESULTING FROM THE USE OF THIS PRODUCT, OR ARISING OUT OF ANY BREACH OF THIS WARRANTY. (As examples, this excludes damages for lost time, cost of having someone remove or re-install an installed unit if applicable, or travel to and from the servicer. The items listed are not exclusive, but are for illustration only.) **ALL EXPRESS AND IMPLIED WARRANTIES, INCLUDING THE WARRANTY OF MERCHANTABILITY, ARE LIMITED TO THE PERIOD OF THE LIMITED WARRANTY.**

Some states do not allow the exclusion or limitation of incidental or consequential damages, or limitations on how long an implied warranty lasts, so the exclusions may not apply to you.

This warranty gives you specific legal rights and you may also have other rights, which vary, from state to state. If a problem with this product develops during or after the warranty period, you may contact your dealer or Servicenter. If the problem is not handled to your satisfaction, then write to the warrantor's Consumer Affairs Department at the addresses listed for the warrantor.

PARTS AND SERVICE (INCLUDING COST OF AN IN-HOME SERVICE CALL, WHERE APPLICABLE) WHICH ARE NOT COVERED BY THIS LIMITED WARRANTY ARE YOUR RESPONSIBILITY.

Note

Index

1 080 i..... 16, 19, 21
480 i..... 16, 19
480 p..... 16, 19, 21
720 p..... 16, 19, 21

A
ASPECT button9, 32
Auto shut off31
AV out terminals 11

B
BBE 43
Blocking Message 49

C
Card Menu Screen 69
Channel up / down buttons (projection display)10, 30
CH buttons (Remote Control)..... 9, 30
Component signal input terminals 11

D
DCF 68

F
Freezing pictures 36

H
HDMI Input Terminal 11, 20
HDMI position..... 35

I
ID1 58
Input 1, 2, 3 terminals 11

J
JPEG 68

L
LAMP indicator..... 10, 74
Left screen..... 38
LIGHT button..... 9

M
Main picture 38
MENU button.....9, 24
MUTE button 9, 36

N
Number keys9, 31

O
OK button9, 24

P
PC Card..... 69
POWER button/POWER indicator 10, 22, 30, 74
POWER button (Remote Control) 9, 22

R
R-TUNE button 9
RECALL button9, 31
Receivable Broadcast Types.....37
Remote Control Sensor.....10, 30
Reset User's Memory Functions 49
RGB positions 35
RGB cable18
RGB IN terminals 11
Right screen 38

S
SAP button9, 37
SD Card..... 69
Sound mute 36
SVGA..... 19

T
TEMP indicator..... 10, 74
TV/VIDEO button 9, 35

U
Using stereo system 17
Using VCR..... 14

V
VGA19
VHF/UHF terminal..... 11
Volume +/- buttons (projection display).....10, 30
VOL buttons (Remote Control)..... 9, 30

X
XGA19

Y
Y, P_B, P_R..... 16

Customer' Record

The serial number of this product can be found on its back cover. You should note this serial number in the space provided below and retain this book, plus your purchase receipt, as a permanent record of your purchase to aid in identification in the event of theft or loss, and for Warranty Service purposes.

Model Number

Serial Number

**Panasonic Consumer Electronics Company, Division
of Matsushita Electric Corporation of America**
One Panasonic Way Secaucus New Jersey 07094

**Panasonic Sales Company, Division of Matsushita
Electric of Puerto Rico Inc. ("PSC")**
Ave. 65 de Infanteria, Km 9.5 San Gabriel Industrial Park,
Carolina, Puerto Rico 00985